



Using Avaya 3730 DECT handsets connected to Avaya Aura[®] Communication Manager and IP Office

Release 4.6
Issue 2
September 2017

© 2017, Avaya Inc.
All Rights Reserved.

Note

Using a cell, mobile, or GSM phone, or a two-way radio in close proximity to an Avaya IP telephone might cause interference.

Documentation disclaimer

"Documentation" means information published in varying mediums which may include product information, operating instructions and performance specifications that are generally made available to users of products. Documentation does not include marketing materials. Avaya shall not be responsible for any modifications, additions, or deletions to the original published version of Documentation unless such modifications, additions, or deletions were performed by or on the express behalf of Avaya. End User agrees to indemnify and hold harmless Avaya, Avaya's agents, servants and employees against all claims, lawsuits, demands and judgments arising out of, or in connection with, subsequent modifications, additions or deletions to this documentation, to the extent made by End User.

Link disclaimer

Avaya is not responsible for the contents or reliability of any linked websites referenced within this site or Documentation provided by Avaya. Avaya is not responsible for the accuracy of any information, statement or content provided on these sites and does not necessarily endorse the products, services, or information described or offered within them. Avaya does not guarantee that these links will work all the time and has no control over the availability of the linked pages.

Warranty

Avaya provides a limited warranty on Avaya hardware and software. Refer to your sales agreement to establish the terms of the limited warranty. In addition, Avaya's standard warranty language, as well as information regarding support for this product while under warranty is available to Avaya customers and other parties through the Avaya Support website: <https://support.avaya.com/helpcenter/getGenericDetails?detailId=C20091120112456651010> under the link "Warranty & Product Lifecycle" or such successor site as designated by Avaya. Please note that if You acquired the product(s) from an authorized Avaya Channel Partner outside of the United States and Canada, the warranty is provided to You by said Avaya Channel Partner and not by Avaya.

"Hosted Service" means an Avaya hosted service subscription that You acquire from either Avaya or an authorized Avaya Channel Partner (as applicable) and which is described further in Hosted SAS or other service description documentation regarding the applicable hosted service. If You purchase a Hosted Service subscription, the foregoing limited warranty may not apply but You may be entitled to support services in connection with the Hosted Service as described further in your service description documents for the applicable Hosted Service. Contact Avaya or Avaya Channel Partner (as applicable) for more information.

Hosted Service

THE FOLLOWING APPLIES ONLY IF YOU PURCHASE AN AVAYA HOSTED SERVICE SUBSCRIPTION FROM AVAYA OR AN AVAYA CHANNEL PARTNER (AS APPLICABLE), THE TERMS OF USE FOR HOSTED SERVICES ARE AVAILABLE ON THE AVAYA WEBSITE, [HTTPS://SUPPORT.AVAYA.COM/LICENSEINFO](https://support.avaya.com/LICENSEINFO) UNDER THE LINK "Avaya Terms of Use for Hosted Services" OR SUCH SUCCESSOR SITE AS DESIGNATED BY AVAYA, AND ARE APPLICABLE TO ANYONE WHO ACCESSES OR USES THE HOSTED SERVICE. BY ACCESSING OR USING THE HOSTED SERVICE, OR AUTHORIZING OTHERS TO DO SO, YOU, ON BEHALF OF YOURSELF AND THE ENTITY FOR WHOM YOU ARE DOING SO (HEREINAFTER REFERRED TO INTERCHANGEABLY AS "YOU" AND "END USER"), AGREE TO THE TERMS OF USE. IF YOU ARE ACCEPTING THE TERMS OF USE ON BEHALF A COMPANY OR OTHER LEGAL ENTITY, YOU REPRESENT THAT YOU HAVE THE AUTHORITY TO BIND SUCH ENTITY TO THESE TERMS OF USE. IF YOU DO NOT HAVE SUCH AUTHORITY, OR IF YOU DO NOT WISH TO ACCEPT THESE TERMS OF USE, YOU MUST NOT ACCESS OR USE THE HOSTED SERVICE OR AUTHORIZE ANYONE TO ACCESS OR USE THE HOSTED SERVICE.

Licenses

THE SOFTWARE LICENSE TERMS AVAILABLE ON THE AVAYA WEBSITE, [HTTPS://SUPPORT.AVAYA.COM/LICENSEINFO](https://support.avaya.com/LICENSEINFO), UNDER THE LINK "AVAYA SOFTWARE LICENSE TERMS (Avaya Products)" OR SUCH SUCCESSOR SITE AS DESIGNATED BY AVAYA, ARE APPLICABLE TO ANYONE WHO DOWNLOADS, USES AND/OR INSTALLS AVAYA SOFTWARE, PURCHASED FROM AVAYA INC., ANY AVAYA AFFILIATE, OR AN AVAYA CHANNEL PARTNER (AS APPLICABLE) UNDER A COMMERCIAL AGREEMENT WITH AVAYA OR AN AVAYA CHANNEL PARTNER. UNLESS OTHERWISE AGREED TO BY AVAYA IN WRITING, AVAYA DOES NOT EXTEND THIS LICENSE IF THE SOFTWARE WAS OBTAINED FROM ANYONE OTHER THAN AVAYA, AN AVAYA AFFILIATE OR AN AVAYA CHANNEL PARTNER; AVAYA RESERVES THE RIGHT TO TAKE LEGAL ACTION AGAINST YOU AND ANYONE ELSE USING OR SELLING THE SOFTWARE WITHOUT A LICENSE. BY INSTALLING, DOWNLOADING OR USING THE SOFTWARE, OR AUTHORIZING OTHERS TO DO SO, YOU, ON BEHALF OF YOURSELF AND THE ENTITY FOR WHOM YOU ARE INSTALLING, DOWNLOADING OR USING THE SOFTWARE (HEREINAFTER REFERRED TO INTERCHANGEABLY AS "YOU" AND "END USER"), AGREE TO THESE TERMS AND CONDITIONS AND CREATE A BINDING CONTRACT BETWEEN YOU AND AVAYA INC. OR THE APPLICABLE AVAYA AFFILIATE ("AVAYA").

Avaya grants You a license within the scope of the license types described below, with the exception of Heritage Nortel Software, for which the scope of the license is detailed below. Where the order documentation does not expressly identify a license type, the applicable license will be a Designated System License. The applicable number of licenses and units of capacity for which the license is granted will be one (1), unless a different number of licenses or units of capacity is specified in the documentation or other materials available to You. "Software" means computer programs in object code, provided by Avaya or an Avaya Channel Partner, whether as stand-alone products, pre-installed on hardware products, and any upgrades, updates, patches, bug fixes, or modified versions thereto. "Designated Processor" means a single stand-alone computing device. "Server" means a Designated Processor that hosts a software application to be accessed by multiple users. "Instance" means a single copy of the Software executing at a particular time: (i) on one physical machine; or (ii) on one deployed software virtual machine ("VM") or similar deployment.

License types

Designated System(s) License (DS). End User may install and use each copy or an Instance of the Software only on a number of Designated Processors up to the number indicated in the order. Avaya may require the Designated Processor(s) to be identified in the order by type, serial number, feature key, Instance, location or other specific designation, or to be provided by End User to Avaya through electronic means established by Avaya specifically for this purpose.

Shrinkwrap License (SR). You may install and use the Software in accordance with the terms and conditions of the applicable license agreements, such as "shrinkwrap" or "clickthrough" license accompanying or applicable to the Software ("Shrinkwrap License").

Heritage Nortel Software

"Heritage Nortel Software" means the software that was acquired by Avaya as part of its purchase of the Nortel Enterprise Solutions Business in December 2009. The Heritage Nortel Software is the software contained within the list of Heritage Nortel Products located at <https://support.avaya.com/LicenseInfo> under the link "Heritage Nortel Products" or such successor site as designated by Avaya. For Heritage Nortel Software, Avaya grants Customer a license to use Heritage Nortel Software provided hereunder solely to the extent of the authorized activation or authorized usage level, solely for the purpose specified in the Documentation, and solely as embedded in, for execution on, or for communication with Avaya equipment. Charges for Heritage Nortel Software may be based on extent of activation or use authorized as specified in an order or invoice.

Copyright

Except where expressly stated otherwise, no use should be made of materials on this site, the Documentation, Software, Hosted Service, or hardware provided by Avaya. All content on this site, the

documentation, Hosted Service, and the product provided by Avaya including the selection, arrangement and design of the content is owned either by Avaya or its licensors and is protected by copyright and other intellectual property laws including the sui generis rights relating to the protection of databases. You may not modify, copy, reproduce, republish, upload, post, transmit or distribute in any way any content, in whole or in part, including any code and software unless expressly authorized by Avaya. Unauthorized reproduction, transmission, dissemination, storage, and or use without the express written consent of Avaya can be a criminal, as well as a civil offense under the applicable law.

Virtualization

The following applies if the product is deployed on a virtual machine. Each product has its own ordering code and license types. Note that each Instance of a product must be separately licensed and ordered. For example, if the end user customer or Avaya Channel Partner would like to install two Instances of the same type of products, then two products of that type must be ordered.

Third Party Components

"Third Party Components" mean certain software programs or portions thereof included in the Software or Hosted Service may contain software (including open source software) distributed under third party agreements ("Third Party Components"), which contain terms regarding the rights to use certain portions of the Software ("Third Party Terms"). As required, information regarding distributed Linux OS source code (for those products that have distributed Linux OS source code) and identifying the copyright holders of the Third Party Components and the Third Party Terms that apply is available in the products, Documentation or on Avaya's website at: <https://support.avaya.com/Copyright> or such successor site as designated by Avaya. The open source software license terms provided as Third Party Terms are consistent with the license rights granted in these Software License Terms, and may contain additional rights benefiting You, such as modification and distribution of the open source software. The Third Party Terms shall take precedence over these Software License Terms, solely with respect to the applicable Third Party Components to the extent that these Software License Terms impose greater restrictions on You than the applicable Third Party Terms.

The following applies only if the H.264 (AVC) codec is distributed with the product. THIS PRODUCT IS LICENSED UNDER THE AVC PATENT PORTFOLIO LICENSE FOR THE PERSONAL USE OF A CONSUMER OR OTHER USES IN WHICH IT DOES NOT RECEIVE REMUNERATION TO (i) ENCODE VIDEO IN COMPLIANCE WITH THE AVC STANDARD ("AVC VIDEO") AND/OR (ii) DECODE AVC VIDEO THAT WAS ENCODED BY A CONSUMER ENGAGED IN A PERSONAL ACTIVITY AND/OR WAS OBTAINED FROM A VIDEO PROVIDER LICENSED TO PROVIDE AVC VIDEO. NO LICENSE IS GRANTED OR SHALL BE IMPLIED FOR ANY OTHER USE. ADDITIONAL INFORMATION MAY BE OBTAINED FROM MPEG LA, L.L.C. SEE [HTTP://WWW.MPEGLA.COM](http://www.mpegla.com).

Service Provider

THE FOLLOWING APPLIES TO AVAYA CHANNEL PARTNER'S HOSTING OF AVAYA PRODUCTS OR SERVICES. THE PRODUCT OR HOSTED SERVICE MAY USE THIRD PARTY COMPONENTS SUBJECT TO THIRD PARTY TERMS AND REQUIRE A SERVICE PROVIDER TO BE INDEPENDENTLY LICENSED DIRECTLY FROM THE THIRD PARTY SUPPLIER. AN AVAYA CHANNEL PARTNER'S HOSTING OF AVAYA PRODUCTS MUST BE AUTHORIZED IN WRITING BY AVAYA AND IF THOSE HOSTED PRODUCTS USE OR EMBED CERTAIN THIRD PARTY SOFTWARE, INCLUDING BUT NOT LIMITED TO MICROSOFT SOFTWARE OR CODECS, THE AVAYA CHANNEL PARTNER IS REQUIRED TO INDEPENDENTLY OBTAIN ANY APPLICABLE LICENSE AGREEMENTS, AT THE AVAYA CHANNEL PARTNER'S EXPENSE, DIRECTLY FROM THE APPLICABLE THIRD PARTY SUPPLIER.

WITH RESPECT TO CODECS, IF THE AVAYA CHANNEL PARTNER IS HOSTING ANY PRODUCTS THAT USE OR EMBED THE G.729 CODEC, H.264 CODEC, OR H.265 CODEC, THE AVAYA CHANNEL PARTNER ACKNOWLEDGES AND AGREES THE AVAYA CHANNEL PARTNER IS RESPONSIBLE FOR ANY AND ALL RELATED FEES AND/OR ROYALTIES. THE G.729 CODEC IS LICENSED BY SIPRO LAB TELECOM INC. SEE [WWW.SIPRO.COM/CONTACT.HTML](http://www.sipro.com/contact.html). THE H.264 (AVC) CODEC IS

LICENSED UNDER THE AVC PATENT PORTFOLIO LICENSE FOR THE PERSONAL USE OF A CONSUMER OR OTHER USES IN WHICH IT DOES NOT RECEIVE REMUNERATION TO: (I) ENCODE VIDEO IN COMPLIANCE WITH THE AVC STANDARD ("AVC VIDEO") AND/OR (II) DECODE AVC VIDEO THAT WAS ENCODED BY A CONSUMER ENGAGED IN A PERSONAL ACTIVITY AND/OR WAS OBTAINED FROM A VIDEO PROVIDER LICENSED TO PROVIDE AVC VIDEO. NO LICENSE IS GRANTED OR SHALL BE IMPLIED FOR ANY OTHER USE. ADDITIONAL INFORMATION FOR H.264 (AVC) AND H.265 (HEVC) CODECS MAY BE OBTAINED FROM MPEG LA, L.L.C. SEE [HTTP://WWW.MPEGLA.COM](http://www.mpegla.com).

Compliance with Laws

You acknowledge and agree that it is Your responsibility for complying with any applicable laws and regulations, including, but not limited to laws and regulations related to call recording, data privacy, intellectual property, trade secret, fraud, and music performance rights, in the country or territory where the Avaya product is used.

Preventing Toll Fraud

"Toll Fraud" is the unauthorized use of your telecommunications system by an unauthorized party (for example, a person who is not a corporate employee, agent, subcontractor, or is not working on your company's behalf). Be aware that there can be a risk of Toll Fraud associated with your system and that, if Toll Fraud occurs, it can result in substantial additional charges for your telecommunications services.

Avaya Toll Fraud intervention

If You suspect that You are being victimized by Toll Fraud and You need technical assistance or support, call Technical Service Center Toll Fraud Intervention Hotline at +1-800-643-2353 for the United States and Canada. For additional support telephone numbers, see the Avaya Support website: <https://support.avaya.com> or such successor site as designated by Avaya.

Security Vulnerabilities

Information about Avaya's security support policies can be found in the Security Policies and Support section of <https://support.avaya.com/security>.

Suspected Avaya product security vulnerabilities are handled per the Avaya Product Security Support Flow (<https://support.avaya.com/css/P8/documents/100161515>).

Downloading Documentation

For the most current versions of Documentation, see the Avaya Support website: <https://support.avaya.com>, or such successor site as designated by Avaya.

Contact Avaya Support

See the Avaya Support website: <https://support.avaya.com> for product or Hosted Service notices and articles, or to report a problem with your Avaya product or Hosted Service. For a list of support telephone numbers and contact addresses, go to the Avaya Support website: <https://support.avaya.com> (or such successor site as designated by Avaya), scroll to the bottom of the page, and select Contact Avaya Support.

Regulatory Statements

Australia Statements

Handset Magnets Statement:

Danger:

The handset receiver contains magnetic devices that can attract small metallic objects. Care should be taken to avoid personal injury.

Industry Canada (IC) Statements

RSS Standards Statement

This device complies with Industry Canada licence-exempt RSS standard(s). Operation is subject to the following two conditions:

1. This device may not cause interference, and

2. This device must accept any interference, including interference that may cause undesired operation of the device.

Le présent appareil est conforme aux CNR d'Industrie Canada applicables aux appareils radio exempts de licence. L'exploitation est autorisée aux deux conditions suivantes:

1. L'appareil ne doit pas produire de brouillage, et
2. L'utilisateur de l'appareil doit accepter tout brouillage radioélectrique subi, même si le brouillage est susceptible d'en compromettre le fonctionnement.

Radio Transmitter Statement

Under Industry Canada regulations, this radio transmitter may only operate using an antenna of a type and maximum (or lesser) gain approved for the transmitter by Industry Canada. To reduce potential radio interference to other users, the antenna type and its gain should be so chosen that the equivalent isotropically radiated power (EIRP) is not more than that necessary for successful communication.

Conformément à la réglementation d'Industrie Canada, le présent émetteur radio peut fonctionner avec une antenne d'un type et d'un gain maximal (ou inférieur) approuvé pour l'émetteur par Industrie Canada. Dans le but de réduire les risques de brouillage radioélectrique à l'intention des autres utilisateurs, il faut choisir le type d'antenne et son gain de sorte que la puissance isotrope rayonnée équivalente ne dépasse pas l'intensité nécessaire à l'établissement d'une communication satisfaisante.

This Class B digital apparatus complies with Canadian ICES-003.

Cet appareil numérique de la classe B est conforme à la norme NMB-003 du Canada.

Radiation Exposure Statement

This equipment complies with FCC & IC RSS102 radiation exposure limits set forth for an uncontrolled environment. This equipment should be installed and operated with minimum distance 20cm between the radiator & your body. This transmitter must not be co-located or operating in conjunction with any other antenna or transmitter.

Cet équipement est conforme aux limites d'exposition aux rayonnements ISED établies pour un environnement non contrôlé. Cet équipement doit être installé et utilisé avec un minimum de 20 cm de distance entre la source de rayonnement et votre corps.

Japan Statements

Class B Statement

This is a Class B product based on the standard of the VCCI Council. If this is used near a radio or television receiver in a domestic environment, it may cause radio interference. Install and use the equipment according to the instruction manual.

この装置は、クラスB情報技術装置です。この装置は、家庭環境で使用することを目的としていますが、この装置がラジオやテレビジョン受信機に近接して使用されると、受信障害を引き起こすことがあります。

取扱説明書に従って正しい取り扱いをして下さい。 VCCI-B

Denan Power Cord Statement



Danger:

Please be careful of the following while installing the equipment:

- Please only use the connecting cables, power cord, and AC adapters shipped with the equipment or specified by Avaya to be used with the equipment. If you use any other equipment, it may cause failures, malfunctioning, or fire.
- Power cords shipped with this equipment must not be used with any other equipment. In case the above guidelines are not followed, it may lead to death or severe injury.



本製品を安全にご使用頂くため、以下のことにご注意ください。

- 接続ケーブル、電源コード、ACアダプタなどの部品は、必ず製品に同梱されております添付品または指定品をご使用ください。添付品指定品以外の部品をご使用になると故障や動作不良、火災の原因となることがあります。
- 同梱されております付属の電源コードを他の機器には使用しないでください。上記注意事項を守らないと、死亡や大怪我等など人身事故の原因となることがあります。

México Statement

The operation of this equipment is subject to the following two conditions:

1. It is possible that this equipment or device may not cause harmful interference, and
2. This equipment or device must accept any interference, including interference that may cause undesired operation.

La operación de este equipo está sujeta a las siguientes dos condiciones:

1. Es posible que este equipo o dispositivo no cause interferencia perjudicial y
2. Este equipo o dispositivo debe aceptar cualquier interferencia, incluyendo la que pueda causar su operación no deseada.

Power over Ethernet (PoE) Statement

This equipment must be connected to PoE networks without routing to the outside plant.

U.S. Federal Communications Commission (FCC) Statements

Compliance Statement

The changes or modifications not expressly approved by the party responsible for compliance could void the user's authority to operate the equipment.

To comply with the FCC RF exposure compliance requirements, this device and its antenna must not be co-located or operating to conjunction with any other antenna or transmitter.

This device complies with part 15 of the FCC Rules. Operation is subject to the following two conditions:

1. This device may not cause harmful interference, and
2. This device must accept any interference received, including interferences that may cause undesired operation.

When using IEEE 802.11a wireless LAN, this product is restricted to indoor use, due to its operation in the 5.15 to 5.25GHz frequency range. The FCC requires this product to be used indoors for the frequency range of 5.15 to 5.25GHz to reduce the potential for harmful interference to co channel mobile satellite systems. High-power radar is allocated as the primary user of the 5.25 to 5.35GHz and 5.65 to 5.85GHz bands. These radar stations can cause interference with and/or damage to this device.

Class B Part 15 Statement

For product available in the USA/Canada market, only channel 1~11 can be operated. Selection of other channels is not possible.

This equipment has been tested and found to comply with the limits for a Class B digital device, pursuant to Part 15 of the FCC Rules. These limits are designated to provide reasonable protection against harmful interferences in a residential installation. This equipment generates, uses and can radiate radio frequency energy and, if not installed and used in accordance with the instructions, may cause harmful interference to radio communications. However, there is no guarantee that interference will not occur in a particular installation. If this equipment does cause harmful interferences to radio or television reception, which can be determined by turning the

equipment off and on, the user is encouraged to try to correct the interference by one or more of the following measures:

- Reorient or relocate the receiving antenna.
- Increase the separation between the equipment and receiver.
- Connect the equipment into an outlet on a circuit different from that to which the receiver is connected.
- Consult the dealer or an experienced radio/TV technician for help.

Radiation Exposure Statement

This equipment complies with FCC radiation exposure limits set forth for an uncontrolled environment. This equipment should be installed and operated with minimum distance of 8 in or 20 cm between the radiator and your body. This transmitter must not be co-located or operating in conjunction with any other antenna or transmitter.

EU Countries

This device complies with the essential requirements and other relevant provisions of Radio Equipment Directive 2014/53/EU. A copy of the Declaration may be obtained from <http://support.avaya.com> or Avaya Inc., 4655 Great America Parkway, Santa Clara, CA 95054–1233 USA.

General Safety Warning

- Use only the Avaya approved Limited Power Source power supplies specified for this product.
- Ensure that you:
 - Do not operate the device near water.
 - Do not use the device during a lightning storm.
 - Do not report a gas leak while in the vicinity of the leak.

Trademarks

The trademarks, logos and service marks (“Marks”) displayed in this site, the Documentation, Hosted Service(s), and product(s) provided by Avaya are the registered or unregistered Marks of Avaya, its affiliates, its licensors, its suppliers, or other third parties. Users are not permitted to use such Marks without prior written consent from Avaya or such third party which may own the Mark. Nothing contained in this site, the Documentation, Hosted Service(s) and product(s) should be construed as granting, by implication, estoppel, or otherwise, any license or right in and to the Marks without the express written permission of Avaya or the applicable third party.

Avaya is a registered trademark of Avaya Inc.

All non-Avaya trademarks are the property of their respective owners. Linux® is the registered trademark of Linus Torvalds in the U.S. and other countries.

Contents

Chapter 1: Introduction	9
Purpose.....	9
Change history.....	9
Chapter 2: Avaya 3730 DECT handset overview	10
Avaya 3730 DECT handset overview.....	10
3730 DECT handset physical layout.....	10
Avaya 3730 DECT handset	12
Functions.....	12
Accessories.....	13
DC3 Desktop Charger and DP1 Desktop Programmer.....	14
CR3 Charging Rack.....	15
373x Accessories.....	15
Icons and text in the display.....	16
Icons.....	17
Menu Icons.....	18
373x Keys and buttons.....	19
Chapter 3: Menu Tree	22
Calls.....	22
Contacts.....	23
Settings.....	25
In call.....	26
Chapter 4: Basic Operation	28
Turning the handset on or off.....	28
Turning the audible signal on or off.....	28
Locking and unlocking the keypad.....	29
Locking and unlocking the keypad in idle mode.....	29
Locking and unlocking the keypad during a call.....	29
Locking and Unlocking the handset.....	30
Muting ringtone for incoming call or message.....	30
Chapter 5: Menu operation	31
Managing incoming calls.....	31
Incoming call.....	31
Answering a call.....	31
Ending a call.....	31
Managing call list.....	32
Call list.....	32
Managing calls in absentia.....	35
Call services.....	35
Managing Mid-call operations.....	36

- During a call..... 36
- Managing outgoing calls..... 42
 - Making a local call..... 42
 - Dialing a number from the call list..... 43
- Managing contacts..... 43
 - Contacts..... 43
 - Calling a number from contacts..... 44
 - Calling a contact from the local or company phonebook..... 44
 - Calling a contact from the central phone book..... 45
 - Adding a contact..... 45
- Messaging..... 47
 - Mini Messaging..... 47
 - Voice mail..... 48
- Chapter 6: Advanced Functions..... 49**
 - Admin menu..... 49
 - Clearing lists in charger..... 49
- Chapter 7: System Handling..... 51**
 - Software upgrade and additional features..... 51
 - Handset updates via the charging rack..... 51
- Chapter 8: Operation Notice..... 53**
 - Operation Notice..... 53
- Chapter 9: Troubleshooting..... 54**
 - Operational problems..... 54
 - Error or warning messages..... 55
- Chapter 10: Customizing Avaya 3730 handset..... 57**
 - Settings..... 57
 - Adjusting the ring volume..... 57
 - Setting different ring signals for calls..... 57
 - Setting the vibrator alert..... 58
 - Setting the key sound..... 58
 - Time and Date Settings..... 59
 - Time and date settings..... 59
 - Setting the time format..... 59
 - Setting the date format..... 59
 - Phone lock settings..... 60
 - Activating automatic phone lock..... 60
 - Deactivating automatic phone lock..... 61
 - Changing the PIN code..... 61
 - Call answering settings..... 62
 - Setting the call answering key..... 62
 - Setting the call answering behavior..... 62
 - Changing the menu language..... 63
 - Setting the Owner ID..... 63

In Charger.....	63
Changing the system.....	64
Subscribing handset in DECT system.....	64
Unsubscribing the system.....	65
Renaming the system.....	65
Setting priority.....	66
Display Settings.....	66
Changing the screen saver.....	66
Changing brightness.....	67
Chapter 11: Maintenance.....	68
Maintenance.....	68
Maintenance of Batteries.....	68
Attach the hinge-type clip.....	69
Attach the swivel-type clip.....	69
Easy Replacement of Handset.....	70
Chapter 12: Energy efficiency.....	73
Chapter 13: Related resources.....	74
Documentation.....	74
Appendix A: Safety Precautions.....	75
Safe operation.....	75
Regulatory Compliance Statements.....	75
Exposure to radio frequency signals.....	75
Regulatory Compliance Statements (USA and Canada only).....	76
FCC and IC compliance statements.....	76
Exposure to radio frequency signals.....	77
Precautions.....	77
Handset.....	77
Battery.....	78
Glossary.....	79

Chapter 1: Introduction

Purpose

This document describes how to use product features and capabilities.

This document is intended for people who want to learn how to use product features and capabilities.

Change history

Issue	Date	Summary of changes
1	July 2017	First issue for Release 4.6

Chapter 2: Avaya 3730 DECT handset overview

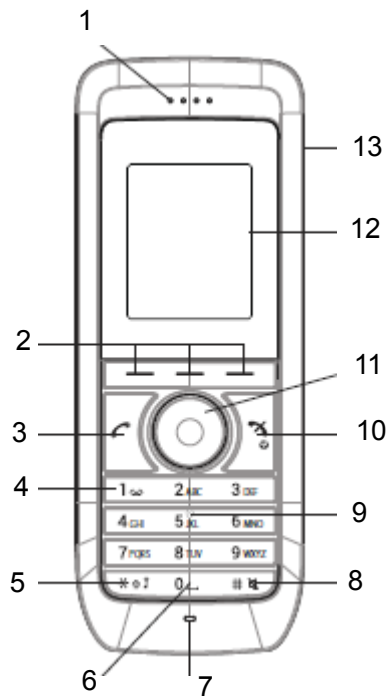
Avaya 3730 DECT handset overview

The Avaya 3730 DECT handset is an extremely user-friendly handset, designed to facilitate efficient and dependable communication. It is ideally suited work in office, retail and academic environments and benefit from its flexible functionality, excellent voice quality and intuitive operation.

3730 DECT handset has the following rich features:

- Color display
- Mini Received message

3730 DECT handset physical layout







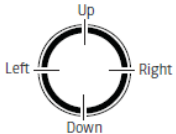
Callout number	Name	Button Icon	Description
1	Earpiece speaker	••••	-
2	Soft keys		Can be pre-programmed or used with the GUI.
3	Off hook key		Used for:
4	Voicemail access	N/A	Gives a quick access to the handset Voicemail. This is a system dependent feature.
5	Key lock, and Upper and Lower case	N/A	Used for: <ul style="list-style-type: none"> • Locking the keypad in combination with the soft key Lock. • Switching between upper or lower case and digits.
6	Space	N/A	Adds space between text.
7	Microphone		-
8	Sound off key	N/A	Used to: <ul style="list-style-type: none"> • Turning on or off audible signals in an idle mode. • Silencing the ring signal at incoming call. • Turning the microphone on or off during a call.
9	Tactile indicators	N/A	Indicates the centre of the key pad.
10	On hook and On/Off key		Used as a combined button: <ul style="list-style-type: none"> • To end a call • To return to the standby mode • To switch the handset on or off by long press
11	Four-way navigation key		Navigation key with Left, Right, Up, and Down. During a call, the keys Up and Down are used to increase and decrease the speaker volume, respectively.
12	Color display	N/A	The color display is a 1.77 inch TFT with backlighting.

Table continues...

Callout number	Name	Button Icon	Description
13	Headset connector		<p>The headset connector is for connecting a headset. The connector is protected against dust by using the headset connector cover.</p> <p>This is a system dependent feature.</p>

Avaya 3730 DECT handset

! Important:

The handset may retain small magnetic objects around the mouthcap or earcap region.

Parts of the handset	Description
Case	The plastic cover parts are made of durable PC/ABS material.
Antenna	The antenna is integrated inside the handset.
Loudspeaker	The handset has a separate loudspeaker for the loudspeaker function. The loudspeaker is placed on the back side of the handset.
Microphone	The microphone is placed on the front bottom side of the handset.
Clip	<p>There are two different belt clip options to the handset: a hinge-type clip (standard) or a swivel-type clip.</p> <p>Use the clip to attach the handset to a belt or similar.</p> <p>You can use the handset without any clip.</p>
Battery	The battery is a rechargeable Li-Ion battery, placed under a battery cover. The battery is fully charged within four hours.

Functions

***** Note:

Some functions are license/system dependent or require settings in handset via WinPDM/ Device Manager.

Table 1: Functions of 3730 DECT handset

Functions	3730 DECT handset
Contacts (250 contacts)	✓
Central phonebook	✓
Company phonebook (500 contacts)	✓
Voicemail access	✓
Vibrator	✓
Headset connector	✓
Microphone on/off during call	✓
Loudspeaking function	✓
Mini messaging (12 characters)	✓
Centralized management	✓
Downloadable languages	✓
Easy registration	✓
Enhanced DECT Security	✓
Easy replacement of handset	✓
Dynamic output power	✓

Accessories

- Desktop charger
- Desktop programmer
- Charging rack

- Carrying case
- Belt Clip
 - hinge-type
 - swivel-type
- Security cord
- Headset with microphone on boom
- Headset with microphone on cable

Related links

[DC3 Desktop Charger and DP1 Desktop Programmer](#) on page 14

[CR3 Charging Rack](#) on page 15

DC3 Desktop Charger and DP1 Desktop Programmer



Figure 1: Chargers

You can use any of the following chargers:

- DC3 Desktop charger: Charges the handset only. The charger is delivered with a plug-in power supply and connected to an ordinary wall socket.
- DP1 Desktop Programmer: Downloads new software and synchronizes parameters. The handset becomes fully operational when you keep it in a charger.

* Note:

Use the charger within the temperature range of +5° C – +40° C.

Related links

[Accessories](#) on page 13

CR3 Charging Rack

The CR3 Charging Rack is used for:

- Charging several handsets
- Synchronizing parameters
- Downloading software

Related links

[Accessories](#) on page 13

373x Accessories

Belt Clips

The two belt clip options are:

- Hinge-type clip: The clip on the back of the handset is used to fasten the handset to a belt or similar. The clip can also be changed to a swivel-type.
- Swivel-type clip: The ordinary belt clip can be replaced with a special swivel-type belt clip that is adapted to firmly place your handset onto your belt.

Security Cord

The security cord is 800 mm long and is attached directly to the handset.

Carrying case

The carrying case is especially designed for the handset and comes with a swivel type belt clip. The handset is fully operational while placed in the carrying case.

Headset

A headset is recommended if the handset is frequently used or the user want to have both hands free.

The headset comes in the following two versions:

- Microphone integrated in the cable
- Microphone on a boom

In order to achieve optimal audio quality with the different headset types it is recommended to select the corresponding headset profile

Changing the headset profile

About this task

The default setting is microphone on a boom, that is, the audio is optimized for using a headset with microphone on a boom. Use the following procedure to change the headset profile in the menu.

Procedure

1. Select **Headset**.
2. Select the corresponding headset profile from the following list:
 - **Mic on boom**
 - **Mic on cable**
 - **Hearing protection**
 - **Customized headset profile:** Only visible if the headset profile has been configured in the WinPDM or Device Manager.
3. Press **Select**.

Icons and text in the display

All functions and settings available to the user are shown as icons and text in the display. The icons and text in the display indicate functions and settings to which you have access. The display normally displays date and time, the Owner ID and telephone number. The Owner ID can manually be set by the user.

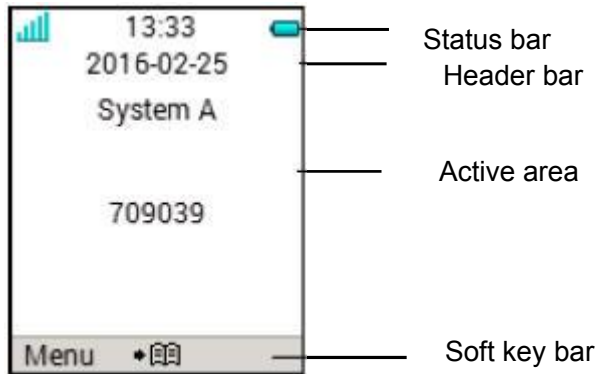


Figure 2: Example of a display configuration in stand by mode

Name	Description
Status bar	This is the top row that is used for icons which provide information for signal strength, missed call, new message, phone lock, key lock, sound off, time and battery status. This row is always visible in all screens.
Header bar	This row displays the current date, headset connection, and system connection.
Active area	This row contains information such as, profiles, the name of the system to which the handset is connected. A user identity provided from the system and/ or an Owner ID can also be displayed if configured in the Settings menu. This is also the area for pop up text for example, missed calls or to confirm an action.

Table continues...

Name	Description
Soft key bar	This row is used for soft keys that can be used as shortcuts for functions in the handset.
Scroll bar	This is the bottom row that is placed to the right side of the active area. It becomes visible when a menu screen has more than six menus, or if the complete text in a message cannot be displayed on the screen simultaneously.

Icons




















Icon	Name	Description
	Signal strength	This icon is visible in the upper left corner. The staples shown in display depends on the signal strength.
	Full battery	This icon is displayed in upper right corner.
	Low battery warning	This icon is shown when the battery has 10% or less remaining capacity left.
	Empty battery warning	This icon is flashing when the battery has 5% or less remaining capacity left.
	Sound off	This icon is displayed when the Sound off key or Mute is pressed. This icon is displayed when the Sound off key is pressed and when the handset with the in charger function Sound off enabled, is placed in a charger.
	Microphone off	This icon indicates a silenced microphone. It is displayed after a long press on the Sound off key, Mute during a call.
	Silent volume	This icon is displayed when the volume has been set to Silent .
	Loudspeaking	This icon is displayed in the soft key bar during a call. Pressing this icon turns on the loudspeaker.
	Loudspeaking off	This icon is displayed after the soft key for Loudspeaking icon has been pressed. Pressing this icon turns off the loudspeaker.

Table continues...

Icon	Name	Description
	Voicemail message	This icon is displayed in the status bar when there are voicemails. The icon remains until voicemail has been listened to. This icon is displayed in the message inbox when there are voicemails. The icon remains until voicemail has been listened to.
	Key lock	This icon indicates a locked keypad.
	Locked entry	This icon indicates that the contact cannot be edited or deleted by the user.
	Phone lock	This icon indicates a locked handset.
	Headset	This icon indicates that a corded headset is connected to the handset.
	Outgoing call	This icon is added to all outgoing calls in the call list.
	Incoming call	This icon is added to all answered calls in the call list.
	Missed call	This icon is added to all missed calls in the call list.
	Missed call	This icon indicates missed calls in the status bar.
	WinPDM/Device Manager communication	This icon is visible when handset is communicating with WinPDM or Device Manager via advanced charger.

Menu Icons




Icon	Name	Description
	Contacts	Contains all names or numbers in the Contacts list. In addition, a company phonebook* with up to 500 entries can be downloaded to the handset via the WinPDM .

Table continues...

Icon	Name	Description
		A central phonebook* can also be accessed from the Contacts menu. The asterisk (*) denotes system dependency.
	Calls	Contains call lists, call time, and call services*. Call services is configured in the WinPDM or Device Manager . The asterisk (*) denotes system dependency.
	Settings	Contains personal handset settings such as changing the ring volume, selecting language.

373x Keys and buttons



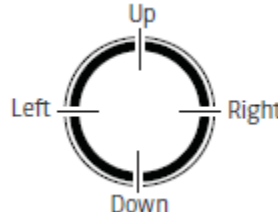

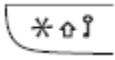
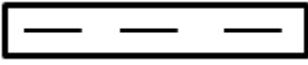
Icon	Name	Description
	Off-hook key	This key is used for connecting calls. One short press in standby mode opens the call list.
	On-hook and On/Off key	This key is used for disconnecting calls and returning to main screen. A long press in standby mode switches the handset on or off.
	Navigation/Confirmation Key	This key is used to step in the menu and when working in text mode. The picture on the left shows how to press the navigation key to step left or right and up or down in the menu. The navigation key can be programmed. Down is a shortcut to Call contact . During a call the volume can be increased or decreased by pressing up and down on the navigation key.
	Sound off key	A long press on the key in idle mode, changes between ring signal on or off. At incoming call, a short press on the key silences the ring signal. During a call, a long press on the key changes between microphone on or off.

Table continues...

Icon	Name	Description
	Key lock, and Upper and Lower case key	This key is to lock the keypad in combination with the soft key Lock. It is also for switching between upper and lower case and digits.
	Soft keys	<p>The three Soft keys are located just beneath the display. The functions of each soft key is indicated by text in the display just above the keys.</p> <p>The middle soft key is by default configured to access the Contacts list, but can be configured to access the Central phonebook or the Contacts menu instead. The soft key is configured in the handset using WinPDM or Device Manager.</p>

373x Alphanumeric Keys

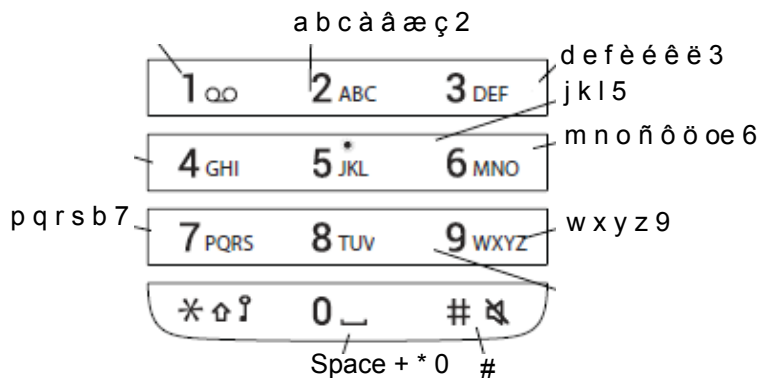


Figure 3: Available characters

In standby mode, and number input mode

- A short press on a key enter the digits 0 - 9 and the characters * and #.
- A long press on the 0 key adds a "+" to the number.
- Enter a pause in number input mode by a long press on the # -key. A pause is indicated by a **P** in the display.
- A long press on the * - key changes the tone sender on. Tone sender on is indicated by a **T** in the display.

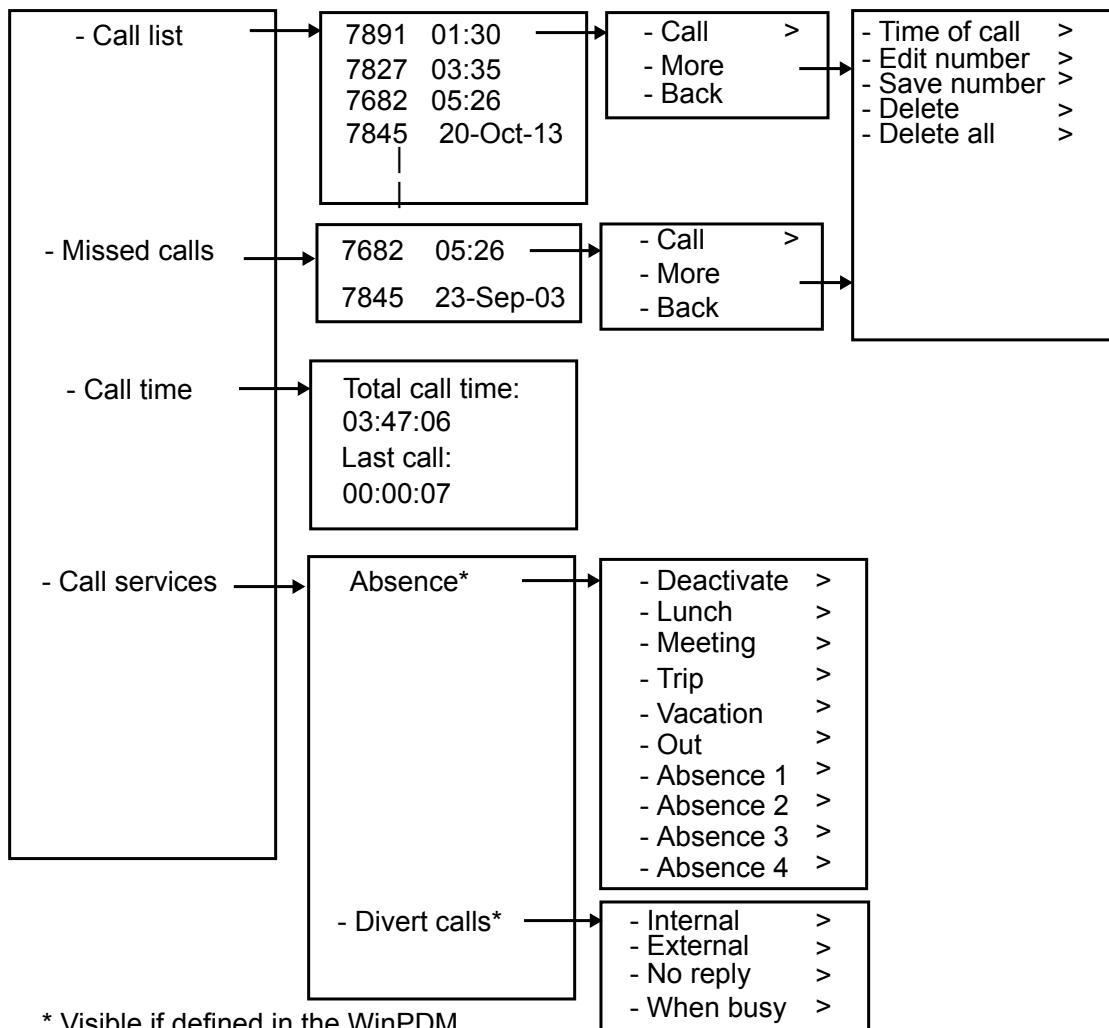
In text input mode

- A short press on a key 0-9, displays the first available character on that specific key. The marked character is selected after a timeout, or when another key is pressed.

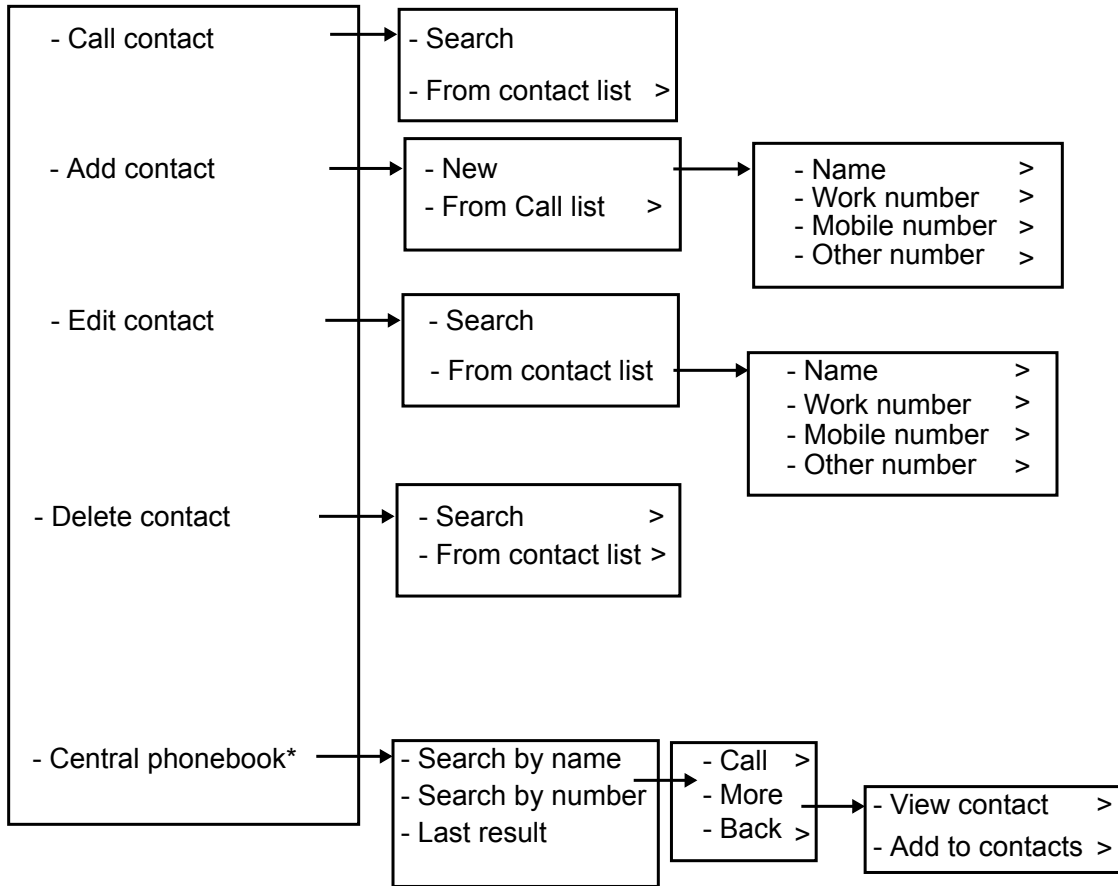
- To change to upper or lower case, press the * -key before entering the character. The * -key can also be used to display only the digits.
- To add space in the text, make a short press on key 0.
- The first character entered in a message, or when adding or editing a name in the **Contacts** menu, is an upper level character. This upper level character is followed by lower level characters, unless the * -key is pressed before entering the character. To switch between Abc, ABC, abc, and 123 the * -key is pressed.
- A long press on the # -key displays special characters.
- A long press on the * -key opens a menu to change writing language. (Default follows the menu language setting).

Chapter 3: Menu Tree

Calls



Contacts

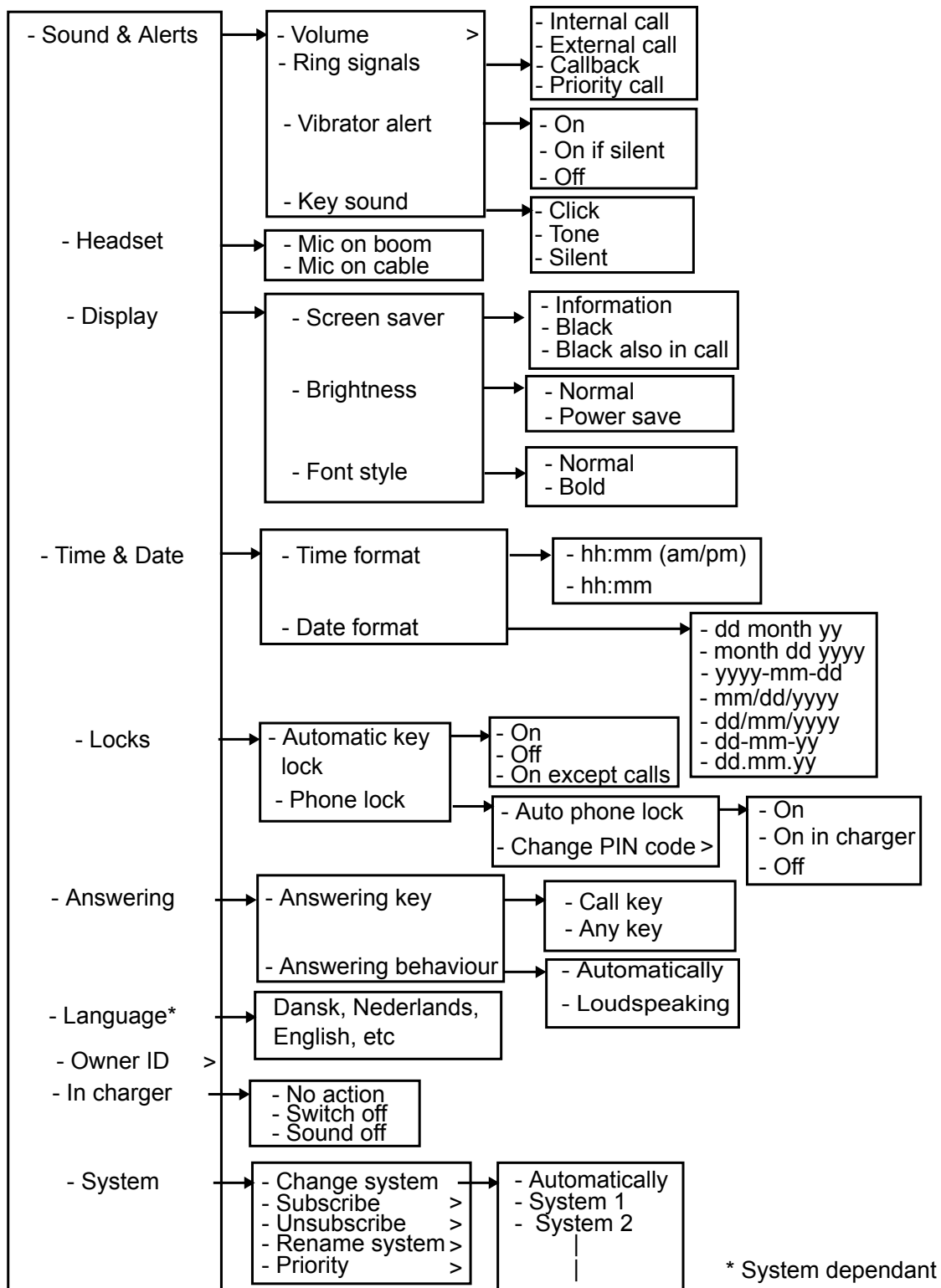


* System dependent.

 **Note:**

The **Call** contacts menu can also be accessed by pressing the soft key in idle mode.

Settings

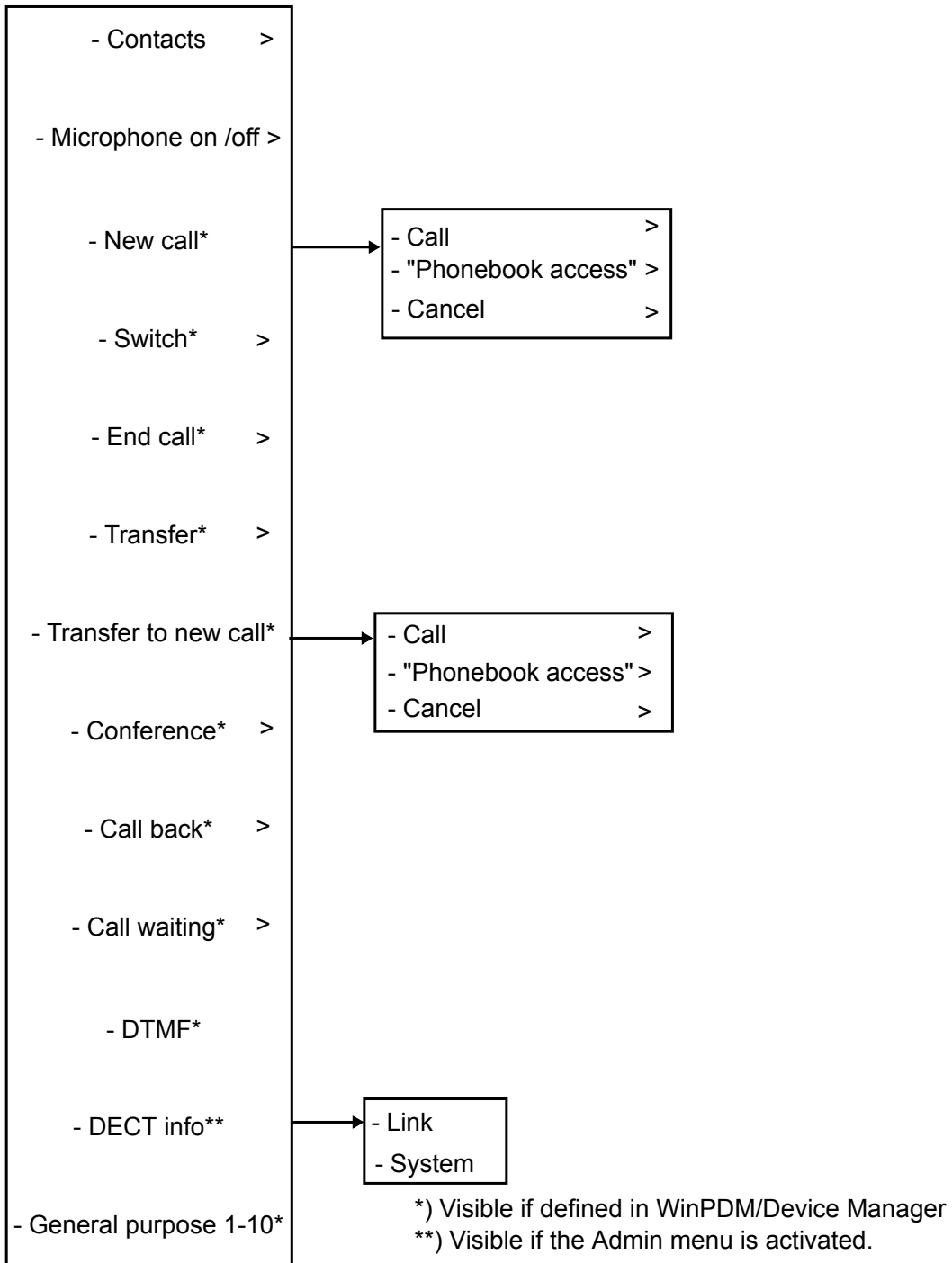


In call

The **In Call** menu displays a list of functions that can be accessed during a call. To see the available functions, press the **More** soft key. Some functions are always provided and others may be made available by the administrator using the WinPDM or Device manager. To use a function, navigate the **In Call** menu to highlight the required function and then press the **Select** soft key.

 **Note:**

If the handset is configured using the WinPDM or Device Manager, a predefined emergency number can be called while the handset or the keypad is locked. If calling from a locked handset, only the Microphone on/off function in the **In Call** menu is accessible. However, the entire **In Call** menu is accessible when calling from a handset with locked keypad.



Chapter 4: Basic Operation

Turning the handset on or off

Before you begin

The handset is turned off or in idle mode.

Procedure

1. Press and hold the **On-hook** key.

The handset vibrates when it is on and the display lights up followed by a confirmation message.

2. To confirm, press the **Yes** soft key.

Note:

The handset returns to idle mode when the **On-hook** key is pressed.

Turning the audible signal on or off



About this task


Use this procedure to turn the audible signal on or off.

Before you begin

The handset is in idle mode or rings.

Procedure

Long press the **Sound off** () key or the **Sound off** () button.

The status of the handset changes between ring signals on or off. The  icon indicates a silenced handset.

Locking and unlocking the keypad


Locking and unlocking the keypad in idle mode

About this task


Use the following procedure to lock the keypad and prevent pressing the keys accidentally.

Procedure

Lock the keypad during a call.

1. To lock the keypad, press the **Key lock, and Upper and Lower case** () key.
2. Press the **Lock** soft key.

Unlock the keypad during a call.

3. To unlock the keypad, press the **Key lock, and Upper and Lower case** () key.
The system displays the message `UnLock?`.
4. Press the **Yes** soft key.

* Note:

You can answer or reject an incoming call when the keypad is locked. If the WinPDM or Device Manager has an emergency call configured, you can make an emergency call when the keypad is locked.

Locking and unlocking the keypad during a call

About this task


Use this procedure to lock the keypad during a call and prevent pressing the keys accidentally. This is useful when a headset is used and the handset is attached to a pocket or a belt.

Procedure

Lock the keypad during a call.

1. To lock the keypad, press the **Key lock, and Upper and Lower case** () key.
2. Press the **Lock** soft key.

Unlock the keypad during a call.

3. To unlock the keypad, press the **Key lock, and Upper and Lower case** () key.
The system displays the message `UnLock?`.
4. Press **Yes**.

Locking and Unlocking the handset

About this task

The handset can be protected for unauthorized use. If this function is activated, a PIN code has to be entered, for example, to switch on the handset, to answer an incoming call etc. The default phone lock code (0000) can be changed to any 4 - 8 digit personalized code.

Procedure

1. Press **Menu**.
2. Select **Settings**.
3. Select **Locks**.
4. Select **Phone lock**.
5. Select **Auto phone lock**.
6. Select **On**, **On in charger**, or **Off**.

 **Note:**


If configured in the **WinPDM** or **Device Manager**, you can call any one of up to five emergency numbers while the handset is locked.

Muting ringtone for incoming call or message

About this task

You can mute the handset ringtone on an incoming call or message. The call is not hung up when the ringtone is muted. If the call is unanswered, it will revert to voicemail if the handset has been configured for voicemail.

Procedure

Long press the **Sound off** () key while the handset is ringing.

Chapter 5: Menu operation

Managing incoming calls



Incoming call

The flashing LED, accompanied by a ring signal and / or a vibrating handset, gives a notice of a call. You can disable a ring signal and a vibrator. The handset number or name of the calling party is shown. The name is shown if the handset number of the calling party is stored in the local phone book.

Answering a call

Procedure

Do one of the following:

- Press the **Off-hook** () or the **Accept** soft key.
- Press  to answer the call using the speakerphone.

The name or number of the calling party is displayed if calling line information is available.

* Note:

- When you enable **Automatically**, all incoming calls are connected automatically.
- If you decline the call, you can still acknowledge its receipt by sending a predefined text message to the caller.

Ending a call

Before you begin

A new call has been started during a conversation.

Procedure

1. Press **More**.

2. Select **End Call**.

The **End Call** option is visible only when it is defined in the WinPDM.

3. Press **Select**.

The handset ends the current call and resumes the previous call.

Managing call list

Call list

You can see the last 25 received, dialled, or missed calls that are stored in the call list. If a phone number occurs more than once, the last time stamp and the total number of occurrences are listed. From the menu, you can see call list under **Calls > Call list**.

Viewing the time of a call

Procedure

1. Press **Menu**.

2. Select **Calls > Call list**.

3. Select a number from the call list.

You can scroll the call list with the up and down arrows on the navigation key.

4. Press **More**.

5. Select **Time of call**. The time and date is displayed for the selected number.

 **Tip:**

The duration of the last call is displayed under **Call time**.

Editing a number from the call list

Procedure

1. Press **Menu**.

2. Select **Calls**.

3. Select **Call list**.

4. Select a number from the call list.

You can scroll the call list with the up and down arrows on the navigation key.

5. Press **More**.
6. Select **Edit number** to edit the selected number.

Saving a number from the call list

About this task

Saving a number in the call list creates a new contact. However, existing items in the call list are not updated with the contact information.

Procedure

1. Press **Menu**.
2. Select **Calls**.
3. Select **Call list**.
4. Select a number from the call list.
You can scroll the call list using the navigation key up and down.
5. Press **More**.
6. Select **Save number**.


Deleting entries from the call list

Procedure

1. Press **Menu**.
2. Select **Calls**.
3. Select **Call list**.
4. Select a number from the call list.
You can scroll the call list with the up and down arrows on the navigation key.
5. Press **More**, and then do the following as required:
 - To delete an entry: Select the entry to delete, and then press **Delete > Yes**.
 - To delete all entries: Press **Delete all**.

Viewing missed calls

About this task

By default the system displays the Missed call window and the **Missed calls** () icon.

The dialog window that appears for a missed call can be turned off. The handset can also be prevented from storing calls in the call list. The **Call list** can be used to ensure privacy for users sharing the same handset. These features require configuration in the handset via **WinPDM** or **Device Manager**.

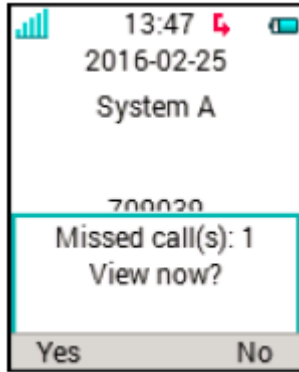


Figure 4: Missed calls

Procedure

The system displays a Missed call window and the **Missed calls** () icon.

1. To view the missed calls, press **Yes**.

The user presses **No**.

2. Press **Menu**.
3. Select **Calls > Missed calls**.
4. To scroll in the list, press up and down on the navigation key.
5. To call back, press **Call**.
6. **(Optional)** In a **Call list**, press **More** to view the time and date of the call, edit the received number, add to contacts, and delete the received number.

If supported by the system, the numbers contact name is displayed in the list.

Viewing the time of a call

Procedure

1. Press **Menu**.
2. Select **Calls > Call list**.
3. Select a number from the call list.
You can scroll the call list with the up and down arrows on the navigation key.
4. Press **More**.
5. Select **Time of call**. The time and date is displayed for the selected number.

Tip:

The duration of the last call is displayed under **Call time**.

Emergency calls

If configured in the **WinPDM** or **Device Manager**, any one of up to five emergency numbers can be called. An emergency number can be called even if the handset or keypad is locked.

Managing calls in absentia

Call services

These functions are system dependent. Besides the default **Call services** functions, 10 extra system specific call services can be defined with or without automatic disconnection. The parameters are set up in the Portable Device Manager (WinPDM).

Absence handling

Procedure

1. Press **Menu**.
2. Select **Calls**.
3. Select **Call services > Absence**.
4. Select the applicable absence reason in the list. The number of absence reasons (for example: "Lunch", "Meeting", "Trip", etc.) are configured in the WinPDM.

The code is defined when configuring the absence reason in the handset.

5. Press **Select**.
6. Enter time (HHMM) or date (MMDD) depending on the selected absence reason.
7. Press **OK**.

The handset sends an absence reason code to the system by establishing a call. The call is automatically disconnected after a few seconds.

Deactivating the Absence settings

Procedure

1. Press **Menu**.
2. Select **Calls**.
3. Select **Call services > Absence**.
4. Select **Deactivate**.
5. Press **Select**.

Diverting calls

About this task

You can divert internal calls, external calls, calls when busy, and calls on no reply to another phone number.

Procedure

1. Press **Menu**.
2. Select **Calls**.
3. Select **Call services > Divert calls**.

You can create a shortcut to the **Call services** function or activate a call service when a profile is activated.

You can set the PBX settings for the call diversion to show the **Divert calls** menu in the handset.

4. Select **Activate**.
5. Select any of the following:
 - **Internal** or **External**: Diverts internal or external calls.
 - **No reply**: Diverts calls on no reply.
 - **When busy**: Diverts calls when the handset sends a busy tone or is on another call.
6. Enter the number (maximum 24 digits) to which you want to divert the calls. Alternatively, press the **Call Contact list** (***[Call Contact List]**) to see the call contact list.
7. Press **OK**.

The handset sends a diversion reason code to the system by establishing a call. The call is automatically disconnected after a few seconds.

The code is defined while configuring the diversion reason in the handset.

Next steps

To stop diversion, select **Deactivate** and press **OK**.

Managing Mid-call operations

During a call

If the handset is configured via Win PDM or Device Manager, one of the predefined emergency numbers can be called while the handset or keypad is locked. When calling from a locked handset, only the **Microphone on** or **Microphone off** function can be accessed by pressing the soft key **More**. When you call from handset with locked keypad, the entire **In Call** menu is accessible.

Adjusting the volume during a call

About this task

Use this procedure to increase or decrease the volume during an ongoing call.

Procedure

Do the following:

- To increase the volume, press the **Volume up** button.
- To decrease the volume, press the **Volume down** button.
- To adjust the volume using a navigation key, press up or down on the navigation key.

The handset stores and keeps the new volume level.

Opening contacts during the call

About this task

Use this procedure to open contacts while you are on a call.

Procedure

1. Select **More**.
2. Select **Contacts**.
3. To open the contacts, select any of the following:
 - **Call contact**: For searching a local or company phone book contact.
 - **Central phonebook**: For searching a central phone book contact.
4. Press **Select**.
5. Select or search contact.

The selected contact can be called by pressing **Call**. When calling the contact, the first call is put on hold.


Turning microphone on or off during a call

Procedure

Turn the microphone off.


1. To turn the microphone off, do the following:
 - a. Press **More** during the call.
 - b. Select **Microphone off**.
 - c. Press **Select**.



The icon  indicates a silenced microphone. This means that the other party in an ongoing call cannot hear you.

Turn the microphone on.

2. To turn the microphone on, do the following:
 - a. Press **More** during the call.
 - b. Select **Microphone on**.
 - c. Press **Select**.

You can also turn the microphone on and off by long pressing the **Sound off** () key.

Starting a new call during a call



About this task

Use this procedure to start a new call during an ongoing call.

Procedure

1. Press **More**.
2. Select **New call**.
3. Select **New call**.

The **New call** option is visible only if it is defined in the WinPDM.

4. Press **Select**.
5. Enter the number that you want to call or press the **Call Contact list** () icon to access the phonebook.
6. Press the **Off-hook** () key.

When the new call connects, the first call is put on hold.

toggling between calls

Before you begin

Start a new call.

Procedure

1. Press **More**.
2. Select **Switch**.

The **Switch** option is only visible if it is defined in the WinPDM.

3. Press **Select** to switch to the other call.

Ending a call

Before you begin

A new call has been started during a conversation.

Procedure

1. Press **More**.

2. Select **End Call**.

The **End Call** option is visible only when it is defined in the WinPDM.

3. Press **Select**.

The handset ends the current call and resumes the previous call.

Transferring a call by pressing a key

About this task

Use this procedure to transfer the first call with the second call when you have two ongoing calls.

Procedure

1. Press **More**.

2. Select **Transfer**.

The **Transfer** option is visible only if it is defined in the WinPDM.

3. Press **Select**.

This connects the first caller with the new caller. Your call is automatically disconnected.

Transferring a call by dialing a number

About this task

You this procedure to transfer an ongoing call to a new call.

Procedure


1. Press **More**.

2. Select **Transfer to new call**.

Transfer to new call is visible only when **New call** and **Transfer** are defined in the WinPDM or Device Manager.

3. Press **Select**.

4. Enter the number of the person where the ongoing call is to be transferred or press the **Call Contact list** (•☎) icon to access the phone book.

5. Press the **On-hook and On/Off** () key to the transfer the call.

Starting a conference call

About this task

Use this procedure to initiate a conference call between several participants simultaneously.

Before you begin

A new call is started during the conversation.

Procedure

1. Press **More**.
2. Select **Conference call**.

The **Conference call** option is visible only if defined in WinPDM.

3. Press **Select**.

The person initiating the conference call is the conference leader, and the others are participant members of the conference call.

Calling back

About this task


When a call is made to a busy handset, automatically a callback can be made when the busy handset is free. Use this procedure, when you get a busy tone sound.


Procedure

1. Press **More**.
2. Select **Call back**.

The **Call back** option is visible only if defined in the WinPDM.

3. Press **Select**.

4. Press the **On-hook and On/Off** () key and wait until the handset alerts.

5. When the handset alerts, press the **Off-hook** () key.

The call starts automatically.

Sending call waiting

About this task

Use this procedure to notify the engaged party that another call is trying to reach them.

Procedure

1. Press **More**.
2. Select **Call waiting**.

The **Call waiting** option is visible only if it is defined in the WinPDM.

3. Press **Select**.

The engaged party receives a **Call waiting** signal.

When the line is free it automatically calls the number again. This is system dependent function.

Answering call waiting

About this task

Use this procedure to answer call waiting when you:

- Receive a short tone for another incoming call during an ongoing conversation.
- Receive a beep from the handset and a text display: **Internal call** for internal callers and **External call** for external callers. The handset also displays the name or the phone number of the second caller.

* Note:

You can use **Answer call waiting** function in two different ways depending on the system setup and configuration.

Procedure

During a call, you receive a short tone. To answer the second call, do the following:

1. Press **More**.
2. Select **Answer call waiting**.
3. Press **Select**.

You connect to the new call and the first call is put on hold. When the line is free, the call on hold is automatically dialled again. This is a system dependent feature.

During a call, you receive a beep and a text display. To answer the second call, do the following:

4. Press **Accept**.

The system displays the text `Switch` briefly and transfers to the second call. The first call is put on hold.

5. To end the call with the second caller, press **More > End call**.

You disconnect with the second call and connect with the first call.

6. **(Optional)** Press **Decline** to reject a second call.

The second caller hears a busy tone, and the call is logged as a missed call in the handset.

Enabling DTMF

About this task

Some systems or PBXs require that the handset sends Dual Tone Multi Frequency (DTMF) when pressing the keys. Use this procedure to enable the **DTMF**.

Before you begin

You must be on a call.

Procedure

Do the following:

- Press **More > DTMF > Select**.

DECT Info

DECT info is an advanced function intended for an administrator using the handset to measure RF link and system parameters as part of a troubleshooting or site surveying procedure.

This option is only visible if the **Admin** menu is activated.

Using the loudspeaking function

About this task

To activate the loudspeaking function depends on the choice of answering method.



Procedure

1. Do any of the following:
 - To receive in incoming call, press the left soft key.
 - During a call, press the left soft key.
2. **(Optional)** To turn the loudspeaking function off, press the left soft key.

Managing outgoing calls

Making a local call

Procedure

1. Enter the number.
2. Press **Call** or the **Off-hook** () key.
The system displays the number while dialling.
3. **(Optional)** Do the following as required:
 - To erase the number, press **Clear**.
 - To step, add or delete the digits from the middle of a number, use the navigation key.
 - To turn the tone sender on in a pre-dialled number, long press the **Key lock, and Upper and Lower case** () key.

Dialing a number from the call list


About this task

Use this procedure to dial a number from the call list when the handset is in the idle mode.

Procedure

1. Press **Menu**.
2. Select **Calls**.
3. Select **Call list**, and then select a number.

The system displays the call list that you can scroll using the navigation key up and down.


4. Press **Call** or the **Off-hook** () key to dial the selected number.


Managing contacts


Contacts

The handset has a local phone book with 250 entries, where you can add, delete, and edit names and numbers freely. The phone book lists all names in alphabetical order, where you can add three numbers for each contact: work number, mobile number, and other number.

You can also access a central phone book which is system dependent. You can send a request to a messaging server with the first characters entered, and the messaging server returns a list of names and numbers that matches the search.



In addition, a company phone book with up to 500 entries can be downloaded to the phone via the WinPDM. The local and company phone book can also be accessed by pressing the soft key **Call Contact list** () in idle mode.

You can download a company phone book through the PDM. It is not possible to edit or delete a company phone book contact. These contacts are indicated by the **Locked entry** () icon before their name. The contacts will include only the work number.


When searching for a contact, the input language can be temporarily changed by long pressing the **Key lock, and Upper and Lower case** () key. This can be used to temporarily access characters in a foreign language.

Calling a number from contacts

Procedure



1. Press **Menu**.
2. Select **Contacts**.
3. Select **Call contact**.
4. Select a contact from the list, or search a name or number by entering the characters in the **Search** field.
5. **(Optional)** To search for a contact, you can temporarily change the input language by long pressing the **Key lock, and Upper and Lower case** () key. This can be used to access characters in a foreign language temporarily.
6. Press **Call** or the **Off-hook** () key.

 **Note:**


Contacts can also be accessed by pressing the soft key  in idle mode. The middle soft key is by default configured to access the contact list, but can be configured to access the **Central phonebook** or the **Contacts** menu. The Soft key is configured in the handset using WinPDM or Device Manager.

Calling a contact from the local or company phonebook

Procedure

1. Press **Menu**.
2. Select **Contacts**.
3. Select **Call contact**.
The local and company phone book contacts appears in the same list. The company names are indicated by the **Locked entry** () icon for identification.
4. Select a contact from the list, or search a name or a number by entering the characters in the **Search** field.
5. Press **Call** or the **Off-hook** () key to call the contact.



 **Note:**

The company phonebook can be accessed by pressing the **Call Contact list** () soft key in idle mode.

6. **(Optional)** Using **View > More**, you can edit the contacts from the local phone book and send a message.

Calling a contact from the central phone book

Procedure

1. Press **Menu**.
2. Select **Contacts**.
3. Select **Central phonebook**.
4. Search for a contact in any of the following ways:
 - a. **Search by name:** Enter the first name and the last name or both.
You can enter incomplete names and names that include spaces.
 - b. **Search by number:** Enter the number.
5. **(Optional)** To search for a contact, you can temporarily change the input language by long pressing the **Key lock, and Upper and Lower case** () key. This can be used to access characters in a foreign language temporarily.
6. Press **Search**.
The system displays the search results.
7. **(Optional)** To view the last search results, select **Central phonebook > Last result**.
8. Press **Call** or the **Off-hook** () key to call the contact.

Adding a contact

Procedure

1. Press **Menu**.
2. Select **Contacts**.
3. To add a new contact, select **Add contact > New**.
4. Select **Name** and press **Add**.
5. In the **Name** field, enter the name for the contact, and then press **OK**.
6. Select one of the following:
 - **Work number**
 - **Mobile number**
 - **Other number**

7. Press **Add**.
8. Enter the numbers.

You can include a tone or a pause in the phone number by pressing the **Space** key five times or seven times. In the display, a tone is indicated by a “T” and a pause by a “P”.

9. Press **OK**.
10. Press **Save**.

Adding a contact from the call list

Procedure

1. Press **Menu**.
2. Select **Contacts**.
3. Select **Add contact** > **From call list**, and then select a number from the call list.
4. Press **Add**.
5. Select any of the following:
 - **Work number**
 - **Mobile number**
 - **Other number**
6. Press **Add**.
7. Enter the name for the contact, and then press **OK**.
8. Press **OK**.

If the Force stimuli ringing is enabled, the handset uses the system-provided ring signals instead of the local ring signals. This function is applicable in legacy systems only (stimuli).

9. Press **Save**.


Editing a contact

About this task

Use this procedure to edit local contacts.

Procedure

1. Press **Menu**.
2. Select **Contacts**.
3. Select **Edit contact**.
4. Select the contact, and press **Edit**.

You cannot edit a company phonebook contact. These contacts are indicated by the  icon before their name.

5. Select any of the following:

- **Name**
- **Work number**
- **Mobile number**
- **Other number**

6. Press **Edit**, and then enter the new name or number.

You can include a tone or a pause in the phone number by pressing the **Space** key five times or seven times. In the display, a tone is indicated by a “T” and a pause by a “P”.

7. Press **OK**.

8. Press **Save**.

Deleting a contact

Procedure

1. Press **Menu**.
2. Select **Contacts > Delete contact**.
3. Select the contact that you want to delete, and then press **Delete**.
4. Press **Yes** to confirm.

It is not possible to delete a company phonebook contact. These contacts are indicated by the **Locked entry** (🔒) icon before their name.

Messaging

Mini Messaging

Depending on the model of handset that is used, it can receive text messages with a maximum of 12 characters. When a text message is received, the message alert signal sounds. The message is displayed in a popup window.

*** Note:**

The support for this feature is dependent on the model of handset that is used.

*** Note:**

The message alert signal cannot be changed.

If the received message contains more than 12 characters, the remaining characters are discarded. Only the last received message is displayed. For example, a first message is received and displayed in the popup window. Another message is received and is displayed instead of the prior message which is discarded.

 **Note:**


If the phone is locked with a PIN, the user must unlock the phone to access a received message.

Press **Close** when the message has been read. It is not possible to reply to a message or create and send a new message. The messages are not stored in the handset.

Voice mail

Receiving a voicemail

About this task

When you receive a voicemail, it is indicated by the **Voicemail message** () icon in the status bar, and the phone screen automatically displays the content of the voice mail notification.

Procedure

1. To dial the voicemail, press **Call**.
2. **(Optional)** If you press **Close**, dial the voicemail by long pressing on digit key **1** in standby mode or from the **Inbox** menu.

Checking the voicemail inbox

Procedure

1. From the dialog window, press **Call** to check the voicemail.
2. If you select **Close**, the voicemail can be dialed by long pressing the **1** key in standby mode.

If the system displays the following message `Voice mail number not defined` the voicemail number needs to be configured to the voicemail button. Contact your system administrator.

Chapter 6: Advanced Functions

Admin menu

The system administrators can use the hidden menu in the handset for administration.

The **Admin menu** contains:

- Software, hardware, and IPEI/IPDI information
- DECT link information
- Site Survey Tool
- Fault logging
- Enhanced system menu with ability to alter protection
- Frequency band selection

This option is hidden when the frequency band has been set.

- System menu with ability to alter protection
- Factory reset option

For quick access to the Device Information (DI) menu in idle mode, press the keys containing ***#DI#** (that is ***#34#**). For quick access to IPEI/IPDI, press ***#06#** in idle mode. See the table below.

Information	Code
Software version	*#34#
Hardware version	*#34#
IPEI/IPDI	*#34# or *#06#
User ID	*#34#

Clearing lists in charger

You can set a parameter through the WinPDM or Device Manager to clear messaging lists and call lists that has been stored in the handset.

When the parameter is activated and the function has been downloaded to the cordless telephone, the lists are deleted when placed in a charger. This feature can be useful during administration of handset for new users.

Chapter 7: System Handling

Software upgrade and additional features

You can upgrade the software and additional features or parameters in the handset by using the WinPDM or Device Manager. The following are examples of additional features that you can configure:

- Company phonebook
- Downloadable languages
- Customizing the menu tree
- Licenses

The license(s) can also be added via the **Admin** menu in the handset.

To view the handset's software version, press *#34# in the idle mode.

Handset updates via the charging rack


Whenever there are updates for the handset, you are instructed to leave the handset in a central charging rack so that the handset can be updated with new features and functions. During an update, the handset displays the  icon and the Updating handset message. You can close the message by pressing **OK**.



Figure 5: Handset update while in charger

If you remove the handset from the charger to use it, the update is suspended. The update is resumed when the handset is again placed into the charger.

When the update is complete, the handset displays the `Handset is updated` message. You can close the message by pressing **OK**.

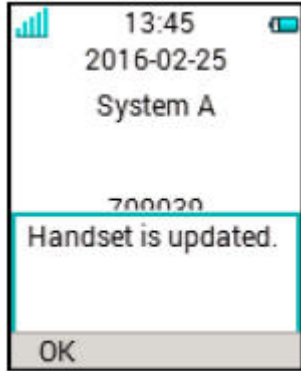


Figure 6: Update completed while in charger

Chapter 8: Operation Notice

Operation Notice

Accessibility and voice quality

The base network is not always available. If you cannot connect with your system, contact your system administrator. For best voice quality, avoid positioning near computer, radio or similar equipment.

Operating area

You can only use your cordless handset in the area that is covered by your system. Outside this area, you will lose contact with the system. The signal strength icon will be low and `Searching` is displayed.

Out of Range

When you leave the system's coverage area a short beep will sound and `Searching` is displayed. The out of range beep is repeated every minute for 30 minutes. The sound can be turned off by long

pressing the **Sound off** () key , or .

When re-entering the coverage area it can take a couple of minutes before the handset automatically has registered into the system.

Chapter 9: Troubleshooting

Operational problems

Fault	Probable cause	Action or comment
No display	The battery level is low or the handset is defective.	Charge the battery or contact system administrator. Sound off is on, or ringer volume set to silent, or the handset is defective.
No ringing	Sound off is on, or ringer volume set to silent, or the handset is defective.	Long press Sound off , or increase volume, or contact system administrator.
No change in time and date setting	PBX dependent.	Changes in the handset appear after a maximum of 24 hours after a change in the system or by turning the handset off and on again.
Cannot mute handset by long pressing Sound off or Mute Not possible to set the ring volume to Silent. Handset, with In Charger > Other actions > Sound off enabled , is not muted when placed in charger.	A handset restriction preventing the user to silence the handset.	Enable the parameter Possible to turn off sound , see the handset's Configuration Manual.
Cannot switch off handset by long pressing On-hook . Handset, with In Charger > Other actions > Sound off enabled , is not switched off when placed in charger.	A handset restriction preventing the user to switch off the handset.	Enable the parameter Possible to switch off handset , see the handset's Configuration Manual.

Error or warning messages

Display shows	Probable cause	Action or comment
No access	The network is in range, but no access rights.	Switch handset Off and then switch it On again or contact system administrator.
No System. The handset beeps once a minute (during max 30 minutes) with a low tone followed by a high tone (if enabled, the vibrator also follows the beeps).	The handset is out of coverage or handset is defective.	Stop the beep with Sound off and go into range. * Note: When re-entering the coverage area it can take a couple of minutes before the handset automatically has registered into the system or contact system administrator.
No flash driver was found * Note: This display message is only shown in English.	Failed to read from flash.	Send the handset for service.
Service needed Hardware error * Note: This display message is only shown in English.	There is a communication problem between components in the handset.	Restart the handset. If the problem persists, send the handset for service.
Service needed Invalid IPDI * Note: This display message is only shown in English.	Easy replacement procedure not followed correctly or failure during easy replacement procedure.	Send the handset for service.
Service needed Parameters corrupt. * Note: This display message is only shown in English.	The handset is defective.	Select Reset on the middle soft key if available or if no Reset option is available or fault does not resolve, the handset needs repair. * Note: Display message only shown in English.
Enter PIN code	The lock of the handset is activated.	Enter the required PIN code. If PIN code lost enter new via PDM/ Device Manager or do a factory reset via PDM/Device Manager.
Battery low, charge now	The battery level is low.	Charge or replace the battery.

Table continues...

Display shows	Probable cause	Action or comment
Phonebook is not available at the moment.	The phone book does not respond, not available at the moment.	Try again later or if fault persists do a factory reset via the Admin menu or PDM/Device Manager.
Voice mail number not defined	There is no Voice mail number defined in the handset.	Define a Voice mail number via PDM/Device Manager.
Could not encrypt connection	The parameter Encryption Required is enabled in the handset in combination with; <ol style="list-style-type: none"> 1. Unencrypted base station(s); and/or, 2. Unsupported base station(s). 	<ol style="list-style-type: none"> 1. Disable the Encryption required parameter in handset via PDM/Device Manager; and/or, 2. Enable the encryption in the base station(s); and/or,
Not allowed	<ol style="list-style-type: none"> 1. The user cannot login to the handset with the shared phone functionality enabled, due to another handset currently using the same extension (User). 2. The user cannot logout from the handset with the shared phone functionality enabled, due to incorrect password (AC code). 3. The extension (User) does not exist. 4. The password is not correct. 	<ol style="list-style-type: none"> 1. Logout from the handset that uses the same extension. 2. Enter #11*<AC code># on the keypad and press Off-hook to logout from the shared phone. 3. Make sure that you entered correct extension. If needed, contact the system administrator. 4. Make sure that you entered correct extension. If needed, contact the system administrator.

Chapter 10: Customizing Avaya 3730 handset

Settings

Adjusting the ring volume

Procedure

1. Press **Menu**.
2. Select **Settings**.
3. Select **Sound & Alerts > Volume**.

Increase and decrease the volume using the left and right arrows on the navigation key.

4. Press **Back** to save the settings.

 **Note:**

If a handset restriction is enabled, it might not be possible to set the ring signal to **Silent**.

Setting different ring signals for calls

About this task

Use this procedure to set different ring signals for calls.

Procedure

1. Press **Menu**.
2. Select **Settings**.
3. Select **Sound & Alerts > Ring signals**.
4. Select one of the following:
 - **Internal call**
 - **External call**

- **Call back:** The option is visible only if it is defined in the **WinPDM** or **Device Manager**.
- **Priority call**

You can set different signals for internal calls, external calls, callback, and priority calls.

5. Select the ring signal.
6. **(Optional)** Press **Play** to listen to a ring signal before selecting it.
The ring signal is repeated until you press **Stop**.
7. Press **Select**.
8. Press **Back** to save the settings.

Setting the vibrator alert

Procedure

1. Press **Menu**.
2. Select **Settings**.
3. Select **Sound & Alerts > Vibrator alert**.
4. Select one of the following:
 - **On**
 - **On if silent:** The vibrator is on when the handset is muted.
 - **Off**
5. Select vibrating alert.
6. Press **Select**.
7. Press **Back** to save the settings.

Setting the key sound

Procedure

1. Press **Menu**.
2. Select **Settings**.
3. Select **Sound & Alerts > Key sound**.
4. Select one of the following:
 - **Silent**
 - **Click**

- **Tone**
5. Press **Back** to save the settings.
 6. **(Optional)** Press **Play** to listen to a key sound before selecting it.

Time and Date Settings

Time and date settings

The DECT system is responsible for keeping the time in the handset. You cannot change the time and date displayed in the handset. The time and date formats displayed in the handset can be changed by the user.

The handset also synchronizes with the DECT system time when:

- The handset is turned off and then turned on. The handset requests the current DECT system date and time.
- The handset is turned on for longer than 24 hours. The handset requests the DECT system time every 24 hours from the time it was last turned on.

Setting the time format

Procedure

1. Press **Menu**.
2. Select **Settings**.
3. Select **Time & Date**.
4. Select the time format. The available options are:
 - hh:mm (am/pm). For example: 1:00pm
 - hh:mm . For example 13:00
5. Press **Select** to save the settings.

Setting the date format

Procedure

1. Press **Menu**.
2. Select **Settings**.

3. Select **Time & Date**.
4. Select the date format. The options are:
 - DD/MM/YYYY, for example, 17/09/2016 (also called Europe)
 - MM/DD/YYYY, for example, 9/17/2016 (also called US)
 - YYYY-MM-DD, for example, 2016-09-17 (ISO 8601)
 - MMM DD YYYY, for example, Sep 17 2016
 - DD MMM YY, for example, 17 Sep 16
 - DD.MM.YYYY, for example, 17.09.2016
 - DD-MM-YYYY, for example, 17-09-2016
5. Press **Select** to save the settings.

Phone lock settings

The handset can be protected for unauthorized use by activating the automatic phone lock. You can configure one of the following options for automatic phone lock:

If this function is activated, a PIN code has to be entered for example to switch on the handset, to answer an incoming call, and so on.

- **On:** The handset is automatically locked if it is not used before the specified auto-lock time expires, or when it is first turned on. The auto-lock time is specified in the **Auto lock time** parameter.
- **On in charger:** The handset is locked immediately when placed in the charger.
- **Off:** The handset is never locked.

You can change the default phone lock PIN code ("0000") to a code of your choice. The code should be of minimum four digits and maximum eight digits.

The **Auto lock time** parameter specifies the time after which the handset is automatically locked. The shortest value is five seconds and the longest is three minutes.

 **Note:**

If this feature is configured in the **WinPDM** or **Device Manager**, you can call any one of the five predefined emergency numbers while the handset is locked.

Activating automatic phone lock

Procedure

1. Press **Menu**.

2. Select **Settings**.
3. Select **Locks > Phone lock > Auto phone lock**.
4. Select one of the following:
 - **On**
 - **On in charger**
5. Enter a PIN code of your choice, and then press **OK**.
The code should be of minimum four digits and maximum eight digits.

 **Note:**

If you forget the PIN code, it can be reset by your distributor.

Deactivating automatic phone lock

Procedure

1. Press **Menu**.
2. Select **Settings**.
3. Select **Locks > Phone lock > Auto phone lock**.
4. Select **Off**.
5. Enter the PIN code, and then press **OK** to deactivate automatic phone lock.

 **Note:**

If you forgot the PIN code, it can be reset by your distributor.

Changing the PIN code

Procedure

1. Press **Menu**.
2. Select **Settings**.
3. Select **Locks > Phone lock > Change PIN code**.
4. Enter the old PIN code, and then press **OK**.
5. Enter the new PIN code again, and then press **Save**.

Call answering settings

The default setting for the handset is to use the **Off-hook** key to answer a call. However, the handset can be configured to answer the call automatically, that is, without pressing a key and in loudspeaking mode if required. Other keys can also be setup to answer a call. If **Any key** is selected, any key, except the **On-hook** key and the **Sound off** key, can be used to answer a call.

Setting the call answering key

Procedure

1. Press **Menu**.
 2. Select **Settings**.
 3. Select **Answering > Answering key**.
 4. Select any of the following:
 - **Call key**
 - **Any key**
 5. Press **Back** to save the settings.
-

Setting the call answering behavior

Procedure

1. Press **Menu**.
2. Select **Settings**.
3. Select **Answering > Answer behavior**.
4. Select any of the following:
 - **Automatically**
 - **Loudspeaking**
5. Press **Change** to change the setting.
The check box is selected.
6. Press **Back** to save the settings.
7. **(Optional)** To remove the settings, press **Change**.
The check box is cleared.

Changing the menu language

Procedure

1. Press **Menu**.
2. Select **Settings**.
3. Select **Language**.
4. Select the language that you want to use for the menu.
5. Press **Back** to save the settings.

 **Note:**

An additional language can be downloaded using the **WinPDM** or **Device Manager**.

Setting the Owner ID

About this task

Use this procedure to set the **Owner ID** to identify the handset.

Procedure

1. Press **Menu**.
2. Select **Settings**.
3. Select **Owner ID**.
4. Enter the name or identity.
5. Press **Save**.

In Charger

Additional In charger actions can be configured in the handset through the **WinPDM** or **Device Manager**.

Switching off while charging

About this task

When the cordless handset is placed in the charger it can be switched off while it is charging. When it is removed from the charger it will switch on again.

When the handset is switched off in the charging rack, the Owner ID of the handset is still shown. This simplifies the identification of the handset. For example, while charging together with other handsets.

Procedure

1. Select **In charger**.
2. Select **Other actions**.
3. Select **Switch off**.

Deactivating the switch off option while in charging mode

Procedure

1. Select **In charger**.
2. Select **Other actions**.
3. Select **No action**.

Changing the system

Procedure

1. Select **System**.
2. Select **Change System**.
3. Select **Automatic** or a specific system.

If the handset is set to **Automatic**, it selects a system according to the priority list.

Automatic cannot be used in both legacy and IP-DECT systems.

Subscribing handset in DECT system

About this task

To subscribe an DECT system manually, you require a Park: (Portable Access Right Key) and Ac: (Authentication code) related to the system.

Procedure

1. Press **Menu**.
2. Select **Connections**.
3. Select **System**.
4. Select **Subscribe**.

The system displays:

- IPDI: A unique code that is assigned to the handset.

5. Press **Next**.
6. **(Optional)** In the **System name** field, enter the system name.

If you do not enter the system name, the default name is used. For example, System A, System B.

7. Press **Next**.
8. Enter **PARK code** (max. 31 digits). The PARK code is not required if there is no alien DECT system within the coverage area.
9. Enter **AC code**. The AC code length must be between 4 - 8 digits.
10. Press **Next**.

The system displays the `Protection on?` message.

11. To protect the new system, select **Yes**.

 **Note:**

You cannot delete a protected system using the **System** menu. The unsubscription must be made using the **Admin** menu or the DECT system.

12. Press **OK**.

A searching mode starts.

Unsubscribing the system

Procedure

1. Press **Menu**.
2. Select **Connections**.
3. Select **System**.
4. Select **Unsubscribe**.
5. Select the system to unsubscribe.
6. Press **Yes**.

Renaming the system

About this task

Use this procedure to change the name of the system in the handset.

Procedure

1. Press **Menu**.
2. Select **Connections**.
3. Select **System**.
4. Select **Rename system**.

5. Select the system to rename and press **Edit**.
6. In the **Name** field, enter new name.
7. Press **Save**.

Setting priority

About this task

The default order of priority is the order of entered subscriptions. This means that the first subscribed system has the highest priority. You can edit the priority list and set the systems in priority by moving them up or down in the list.

This priority list is used in combination with the system set to **Automatic**.

Procedure

1. Press **Menu**.
2. Select **Settings**.
3. Select **System**.
4. Select **Priority**.
5. Change the priority by using the navigation key to scroll up and down.
6. To save the priority, select **Back**.

Display Settings

Changing the screen saver

About this task

You can set the screen saver to one of the following:

- **Information:** Displays status and identification information while the handset is idle.
- **Black:** The screen is black when the handset is idle.
- **Black also in call:** The screen is black when a call is in progress.

When the handset with the screen saver set to **Information** is in a charger, the Owner ID is displayed even if the handset is switched off. This simplifies identification when many handsets are in a charging rack.

Procedure

1. Press **Menu**.

2. Select **Settings**.
3. Select **Display > Screen saver**.
4. Select one of the following:
 - **Information**
 - **Black**
 - **Black also in call**
5. Press **Back**.

 **Note:**

When charging the handset in a DP1 Desktop Programmer or CR3 Charging Rack, information is replaced by the large license indicator shield. When in the desktop charger it is the same as when out of the charger.

Changing brightness

Procedure


1. Press **Menu**.
2. Select **Settings**.
3. Select **Display > Brightness**.
4. Select one of the following:
 - **Normal**
 - **Power save**
5. Press **Select**.
6. Press **Back**.


Chapter 11: Maintenance



Maintenance

Maintenance of Batteries

Battery Warnings



The "Low battery" icon () is displayed when the battery has 10% or less remaining capacity left. In addition; a warning signal sounds every minute, the LED flashing orange, and the dialog window "Battery low. Charge now." is displayed.

The "Empty battery" () icon is flashing when the battery has 5% or less remaining capacity left. In addition; a warning signal sounds every second, the LED flashing red, and the dialog window Battery empty. Shutting down is displayed.

During a call, only the corresponding battery warning signal notifies the user. The warning signal cannot be silenced during a call. When not in call, the warning signal is silenced by pressing the **Sound off** (# ) key or .

Charge the Battery

Place the handset in the desktop charger or in the rack charger. The battery is being charged when the LED on the handset is steady orange. When the battery is fully charged the LED is green.

An animated battery () icon is also shown in the display indicating charging by starting with its current charge and ending with the full charge. A filled battery () icon indicates a fully charged battery.

Note:

Only use the prescribed chargers for charging.

Replace the Battery

If the standby time for the handset becomes too low, the battery should be replaced by a new one. For information about new batteries, please contact your system administrator or your supplier. It is attached inside the battery lid and is connected to the handset in such a way that no misalignment of the contact is possible.

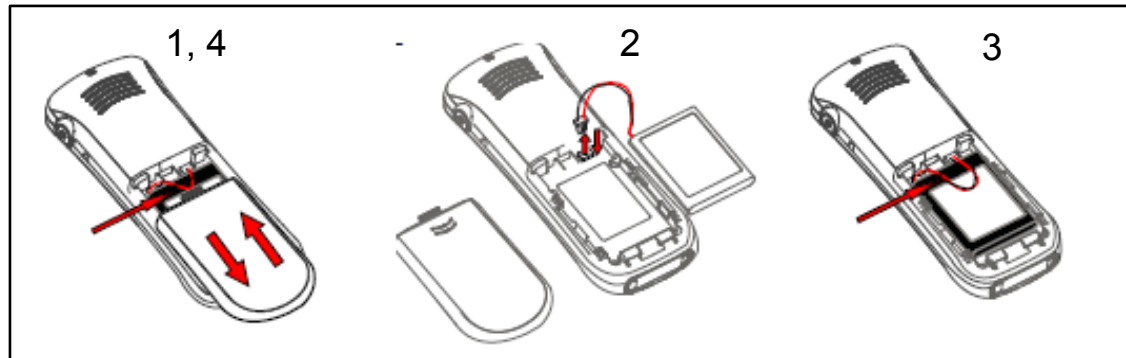


Figure 7: Replaceable battery

Attach the hinge-type clip

Attach the hinge—type belt clip as described in the illustration.

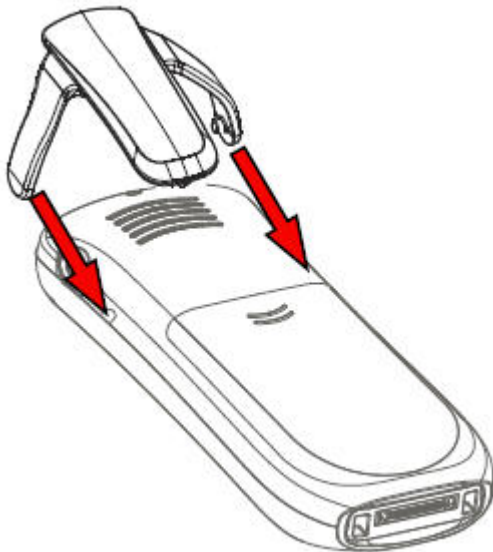


Figure 8: Screw the hinge—type clip into position

Attach the swivel-type clip

Attach the swivel—type belt clip as described in the illustration.

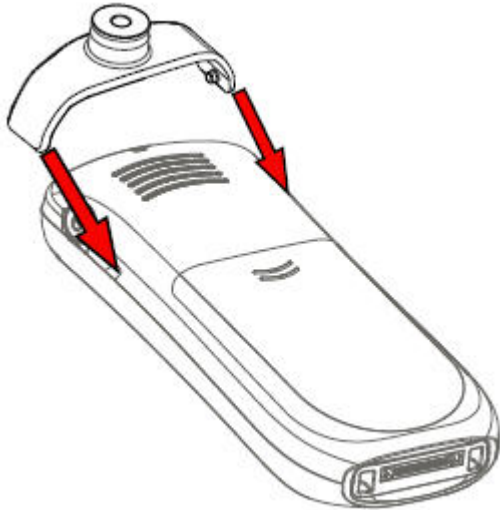


Figure 9: Screw the swivel—type clip into position

Easy Replacement of Handset

Easy replacement can be used if a handset needs to be replaced due to, for example, a broken display.

*** Note:**

Easy replacement is not supported when using DP1 Desktop Programmer.

*** Note:**

If the electrical connection is damaged, it is not possible to follow the Easy Replacement procedure. Depending on the fault, it might work to do a replacement through **WinPDM** or **Device Manager**.

The following settings are replaced during easy replacement:

- DECT registration
- User parameters (including User ID)
- Contacts
- The extension number is assigned to the new handset.

The following settings are not replaced during the easy replacement:


- Call list

Starting Easy Replacement Procedure

About this task

This task suggests necessary requirements before starting easy replacement procedure.

Procedure

1. Check that both the old handset to be replaced and the new replacement handset are of the same device type.
2. Use the WinPDM or the Device Manager to check that the software of DC4 Advanced Desktop Charger or CR3 Charging Rack is of version 1.3.x or greater.
3. Make sure that the handset batteries are charged before starting the easy replacement procedure.
4. Switch off the new handset by long pressing .

Easy Replacement Procedure




About this task

During the Easy Replacement procedure, the LEDs of the handset and the charger follow the same LED indications. This means that if the old handset has a broken display, the LED indications on the charger and on the handset can be used to follow the replacement procedure. Before and after easy replacement, the LEDs may have different LED indications.

Important:

Never remove a handset from the charger until the instructions in the display or the LED tells you to do so (see status on the LED if the display is broken). If there is an error indication it may be allowed to remove the handset. After the old handset has been in the charger, the new handset must be placed in the charger regardless if the replacement was successful or not. Failing to do so may result in malfunction and the new handset will need to be sent for service.

Procedure

1. On the new handset, press and hold .
Do not release  until you are instructed to do so.
2. Put the new handset in the charger.
3. When the system displays the message "Start phone replacement?", release .
Press **Yes** (left soft key).
The system displays the message "Follow the instructions. Each step can take several minutes.".
4. Press **OK** (left soft key).
5. When the text "Please insert old phone in charger" is displayed, replace the new handset with the old handset. The handset can either be switched on or off.

If the CR3 Charging Rack is used, the left charging slot must be used for both handsets.

The handset restarts and after a few seconds, the system displays a message "Saving settings. Do not remove phone from charger". The charger LED changes to slow orange flashing. It may take several minutes.

! Important:

If the old handset cannot communicate with the charger, put the new handset in the charger to restore its settings (the handset's IPDI). If this step is not performed, the new handset must be sent for service. The settings of the old handset can be transferred to the new handset by using PDM/Device Manager.

6. When the system displays the message "Please insert new phone in charger", replace the old handset with the new handset.

The system displays the message "Restoring settings".

! Important:

Do not remove the handset while the message "Restoring settings" is displayed.

7. When the system displays the message "Phone successfully replaced. Please remove phone to restart.", remove the handset from the charger.

The handset automatically restarts.

LED indications during easy replacement

The following table shows the LED indications that are used for the charger during the easy replacement procedure.

LED indication	Description
Orange, flashing (1 000 ms on, 1 000 ms off)	File transfer during Easy Replacement.
Orange, flashing (100 ms on, 800 ms off)	"Change phone" indication during Easy Replacement.
Red, flashing (100 ms on, 800 ms off)	Error indication during Easy Replacement. Put back old handset in charger.
Red, flashing (900 ms on, 100 ms off)	Error during Easy Replacement. Service needed for both handsets.

Chapter 12: Energy efficiency

Recommendations on how to save energy:

- Do not charge a battery when the ambient room temperature is above +40° C or below +5° C (above 104° F or below 41° F). Charging below +5° C harms the battery and shortens the lifetime.
- Note that storing Li-Ion batteries at high temperature dramatically reduces its capacity. For example storage around +60° C reduces capacity with 20% in less than a month, permanently.
- Set the handset screen saver to the **Black also in call** option. The screen goes black and the backlight is turned off. The backlight also turns off when the handset is in call. This helps to extend the battery life when the user is on an extended call.
- The handset can be configured to switch off when placed in the charger. When removed from the charger the handset switches on automatically.
- If the charger is not used for a longer period of time, remove the power adapter to the charger.
- Do not put the handset in charger when charging is not required.

Chapter 13: Related resources

Documentation

You can download the documents you need from the Avaya Support website at <http://support.avaya.com/>.

Installation and Operation

Title	Description	Audience
Installation and Operational Manual	Describes the procedures for installing the IP DECT phones.	Deployment engineers, solution architects, and support personnel.

Configuration

Title	Description	Audience
3730 DECT Handset Configuration Manual	Describes the design, capacity, interoperability, and limitations of the IP DECT handsets.	Sales and deployment engineers, solution architects, and support personnel.

Appendix A: Safety Precautions

Safe operation

For safe and efficient operation of the handset, observe the guidelines given in this manual and all necessary safety precautions when using the handset. Follow the operating instructions and adhere to all warnings and safety precautions located on the product, the Regulatory Information delivered with the handset, and this User Manual. Do not disassemble the handset. Disassembling the handset voids the warranty.

The handset consists of no consumer serviceable components. Service should be performed by an Authorized Service Center only. Changes or modifications to the equipment not expressly approved by the party responsible for compliance could void the user's authority to operate the equipment Frequency Range.

The handset is a radio transmitter and receiver. When it is on, it receives and sends out radio frequency (RF) energy. The handset operates on different frequency ranges depending on market and employs commonly used modulation techniques:

EU (ETSI): 1880-1900 MHz/250mW

USA/Canada (FCC): 1920-1930 MHz/100mW

 **Note:**

Product Designator for regulatory purposes of the Avaya 3730 DECT handset is DH6.

Regulatory Compliance Statements

Exposure to radio frequency signals

	Close to ear	Handheld/body mounted
DH6-xxxx	0.069 W/kg (10g)	0.091 W/kg (10g)

This mobile device meets guidelines for exposure to radio waves. Your mobile device is a radio transmitter and receiver. It is designed not to exceed the limits for exposure to radio waves recommended by international guidelines. These guidelines were developed by the independent scientific organization ICNIRP and include safety margins designed to assure the protection of all persons, regardless of age and health.

The exposure guidelines for mobile devices employ a unit of measurement known as the Specific Absorption Rate or SAR. The SAR limit stated in the ICNIRP guidelines is 2.0 W/kg averaged over 10 grams of tissue.

Tests for SAR are conducted using standard operating positions with the device transmitting at its highest certified power level in all tested frequency bands. The actual SAR level of an operating device can be below the maximum value because the device is designed to use only the power required to reach the network. That amount changes depending on a number of factors such as how close you are to a network base station. The highest SAR value under the ICNIRP guidelines for use of the device at the ear is 0.201 W/kg and at the body is 0.278 W/kg (The measure distance of 1.5 cm). Use of device accessories and enhancements may result in different SAR values. SAR values may vary depending on national reporting and testing requirements and the network band.

Regulatory Compliance Statements (USA and Canada only)

FCC ID:
DH6-xxxx:BXZDH6
IC:
DH6-xxxx3724B-DH6

FCC and IC compliance statements

This equipment has been tested and found to comply with the limits for a Class B digital device, pursuant to part 15 of the FCC Rules. These limits are designed to provide reasonable protection against harmful interference in a residential installation.

This equipment generates, uses and can radiate radio frequency energy and, if not installed and used in accordance with the instructions, may cause harmful interference to radio communications. However, there is no guarantee that interference will not occur in a particular installation. If this equipment does cause harmful interference to radio or television reception, which can be determined by turning the equipment off and on, the user is encouraged to try to correct the interference by one or more of the following measures:

- Reorient or relocate the receiving antennas.
- Increase the separation between the equipment and receiver.
- Connect the equipment into an outlet on a circuit different from that to which the receiver is connected.
- Consult the dealer or an experienced radio or TV technician for help.

 **Note:**

Privacy of communications may not be ensured when using this handset.

Exposure to radio frequency signals

This equipment complies with FCC radiation exposure limits set forth for an uncontrolled environment. This device complies with FCC SAR limit of 1.6 W/kg. The maximum SAR value measured is:

	Head	Body
DH6-xxxx	0.057 W/kg	0.070 W/kg

The handset is designed to be worn with the display towards the body for best radio performance. SAR testing is made with no separation, to approve the device to be carried close to the body. This device must not be co-located or operating in conjunction with any other antenna or transmitter.

Use of non-Avaya approved accessories may violate the FCC and IC guidelines for RF exposure and should be avoided.

Precautions

Handset

- Avoid volume levels that may be harmful to your hearing. Exposure to excessive sound pressure from a handset's earpiece or headset may cause permanent hearing loss.
- Low volume levels might result in missed alerts.
- Only use the handset in temperatures between: -5 °C and +45 °C (23 °F and 113 °F).
- Avoid exposing the handset to direct sunlight, heat sources and moisture.
- Do not place a cold handset in a charger.
- Avoid sudden temperature changes to prevent condensation in the handset. It is recommended to put the handset into an air tight plastic bag until the temperature is adjusted, for example, when entering or leaving a cold or heated building on a warm/cold day.
- If the handset has been exposed to water or condense, remove the battery immediately, and let it dry completely before re-inserting the battery.
- Do not expose the handset to open flame.
- Protect your handset from aggressive liquids and vapors.
- Remove the handset from the charger before cleaning the handset to reduce risk of electric shock.
- Keep the handset away from strong electromagnetic fields.
- The handset may retain small metal objects around the earpiece region.
- Do not place heavy objects on the handset.

- Do not allow children to play with the product packaging material. This could cause choking and or suffocation.
- Do not allow children to play with the handset. It is not a toy.

Battery

- Do not immerse the battery into water. This could short-circuit and damage the battery.
- Do not expose the battery to an open flame. This could cause the battery to explode.
- Do not allow the metal contacts on the battery to touch another metal object. This could short-circuit and damage the battery.
- Do not leave the battery where it could be subjected to extremely high temperatures, such as inside a car on a hot day.
- Use the Desktop Charger, the Charging Rack, or the Battery Pack Charger for charging. Charge the battery for at least one hour the first time you use the battery.
- Do not charge the battery when the ambient room temperature is above 40 °C or below 5 °C (above 104 °F or below 41 °F).
- Do not attempt to take the battery apart.
- Do not remove the battery, unless it needs to be replaced.
- Power off the handset before removing the battery.

 **Note:**

Defective batteries must be returned to a collection point for chemical waste disposal.

Glossary

Device Manager	An application for the management of handsets and charging racks.
Integrated Wireless Messaging and Services	A software that runs on an Elise3 hardware and enables wireless services to and from handsets and chargers.
Portable Device Manager	An application for the management of portable devices and charging racks. Also known as WinPDM.
Unite Connectivity Manager	A unit module that manages users, communication interfaces, message routing, activity logging, and essential messaging services.

Index

Numerics

3730 handset	9
373x	
accessories	15
Alphanumeric keys	20
icons	17
keys and buttons	19

A

Absence handling	35
Absence settings	
Absence settings	35
accessories	13
373x	15
Activating automatic phone lock	60
adding	
new contact	45
Adding	
contact from the call list	46
adjusting	
ring volume	57
adjusting volume	37
admin menu	49
Alphanumeric keys	
373x	20
answering	31, 41
audible signal off	28
audible signal on	28
automatic phone lock	
deactivating	61

B

batteries	68
battery	
precautions	78
between calls	38
toggling	38

C

call	39
call answering behavior	
setting	62
call answering key	
setting	62
Call answering settings	62
calling	
back	40
contact	

number (<i>continued</i>)	
contact (<i>continued</i>)	
local or company phonebook	44
emergency	35
number	
contacts	44
Calling a contact from the central phonebook	45
Call list	32
calls	22, 31
ending	31, 38
incoming	31
call services	
call services	35
diverting	36
Call services	
Absence handling	35
call waiting	40, 41
change	
history	9
changing	
headset profile	15
menu language	63
PIN code	61
system	64
the screen saver	66
Changing brightness	67
charger list clear	49
charging rack	
CR3	15
checking	
voicemail inbox	48
clearing lists	49
conference call	39
configuration	74
contact	
editing	46
contact from the call list	
adding	46
contacts	
number	
calling	44
Contacts	23, 43
calling a contact from the central phone book	45
deleting a contact	47
CR3	
charging rack	15

D

date format	
setting	59
DC3 Desktop Charger	
DP1 Desktop Programmer	14

Index

Mini Messaging	47	screen saver (<i>continued</i>)	
mute ringtone for incoming call	30	changing	66
mute ringtone for message	30	sending	40
muting ringtone	30	setting	
N		call answering behavior	62
new call		call answering key	62
starting	38	date format	59
transferring	39	key sound	58
new contact		Owner ID	63
adding	45	priority	66
number from the call list		ring signals for calls	57
dialing	43	time format	59
O		vibrator alert	58
open contacts during call	37	settings	25
opening contacts	37	Settings	
operation	74	call answering settings	62
operational problems	54	phone lock settings	60
operation notice	53	Software upgrade and additional features	51
Owner ID		starting	39
setting	63	new call	38
P		subscribing	
Phone lock settings	60	handset	64
PIN code		switching off	
changing	61	charging	63
precautions		system	
battery	78	renaming	65
handset	77	unsubscribing	65
priority		System handling	
setting	66	handset updates via the charging rack	51
procedure	71	software upgrade and additional features	51
R		T	
radio frequency signals		time format	
exposure	75, 77	setting	59
receiving		togglng	38
voicemail	48	transferring	39
renaming		new call	39
system	65	turning	
replacement	71	microphone on and off	
replacement procedure	71	during a call	37
ring signals for calls		turning audible signal	28
setting	57	U	
ring volume		unlocking	
adjusting	57	handset	30
S		unsubscribing	
Saving a number from the call list	33	system	65
screen saver		using	
		loudspeaking function	42
		Using the call list	
		deleting entries from the call list	33
		editing a number from the call list	32
		saving a number from the call list	33
		viewing the time of a call	32, 34

V

vibrator alert	
setting	58
viewing	
missed calls	
viewing	33
Viewing the time of a call	32 , 34
voicemail	
receiving	48
volume	
adjusting during a call	37